

Data Projector

Operating Instructions

HDMI[™]
HIGH-DEFINITION MULTIMEDIA INTERFACE

VPL-FE40/FE40L

VPL-FX40/FX40L

VPL-FX41/FX41L

WARNING

To reduce the risk of fire or electric shock, do not expose this apparatus to rain or moisture.

To avoid electrical shock, do not open the cabinet. Refer servicing to qualified personnel only.

WARNING

THIS APPARATUS MUST BE EARTHED.

WARNING

When installing the unit, incorporate a readily accessible disconnect device in the fixed wiring, or connect the power plug to an easily accessible socket-outlet near the unit. If a fault should occur during operation of the unit, operate the disconnect device to switch the power supply off, or disconnect the power plug.

WARNING: THIS WARNING IS APPLICABLE FOR USA ONLY.

If used in USA, use the UL LISTED power cord specified below.

DO NOT USE ANY OTHER POWER CORD.

Plug Cap	Parallel blade with ground pin (NEMA 5-15P Configuration)
Cord	Type SJT, three 16 or 18 AWG wires
Length	Minimum 1.5 m (4 ft .11 in.), Less than 2.5 m (8 ft .3 in.)
Rating	Minimum 10 A, 125 V

Using this unit at a voltage other than 120V may require the use of a different line cord or attachment plug, or both.

To reduce the risk of fire or electric shock, refer servicing to qualified service personnel.

WARNING: THIS WARNING IS APPLICABLE FOR OTHER COUNTRIES.

- 1 Use the approved Power Cord (3-core mains lead) / Appliance Connector / Plug with earthing-contacts that conforms to the safety regulations of each country if applicable.
- 2 Use the Power Cord (3-core mains lead) / Appliance Connector / Plug conforming to the proper ratings (Voltage, Ampere).

If you have questions on the use of the above Power Cord / Appliance Connector / Plug, please consult a qualified service personnel.

IMPORTANT

The nameplate is located on the bottom.

For kundene i Norge

Dette utstyret kan kobles til et IT-strømfordelingssystem.

For the customers in the USA

This equipment has been tested and found to comply with the limits for a Class A digital device, pursuant to Part 15 of the FCC Rules. These limits are designed to provide reasonable protection against harmful interference when the equipment is operated in a commercial environment. This equipment generates, uses, and can radiate radio frequency energy and, if not installed and used in accordance with the instruction manual, may cause harmful interference to radio communications. Operation of this equipment in a residential area is likely to cause harmful interference in which case the user will be required to correct the interference at his own expense.

You are cautioned that any changes or modifications not expressly approved in this manual could void your authority to operate this equipment.

All interface cables used to connect peripherals must be shielded in order to comply with the limits for a digital device pursuant to Subpart B of Part 15 of FCC Rules.

This device complies with Part 15 of the FCC Rules. Operation is subject to the following two conditions: (1) this device may not cause harmful interference, and (2)

this device must accept any interference received, including interference that may cause undesired operation.

For the State of California, USA only

Perchlorate Material - special handling may apply, See

www.dtsc.ca.gov/hazardouswaste/perchlorate

Perchlorate Material: Lithium battery contains perchlorate.

For the customers in Canada

This Class A digital apparatus complies with Canadian ICES-003.

For the customers in Europe, Australia and New Zealand

WARNING

This is a Class A product. In a domestic environment, this product may cause radio interference in which case the user may be required to take adequate measures.

For the customers in Europe

The manufacturer of this product is Sony Corporation, 1-7-1 Konan, Minato-ku, Tokyo, Japan.

The Authorized Representative for EMC and product safety is Sony Deutschland GmbH, Hedelfinger Strasse 61, 70327 Stuttgart, Germany. For any service or guarantee matters please refer to the addresses given in separate service or guarantee documents.

This apparatus shall not be used in the residential area.

For safety

Be sure to attach the air filter to the unit.

For the customers in Taiwan only



廢電池請回收

Table of Contents

Precautions	5
Notes on Installation and Usage	6
Unsuitable Installation	6
Usage in High Altitude	7
Unsuitable Conditions	7

Overview

About the Supplied Manuals	8
Features	8
Location and Function of Controls ..	10
Top/Front/Side	10
Rear/Side/Bottom	10
Control Panel	11
Connector Panel	12
Remote Commander	14

Projecting the Picture

Installing the Projector	16
Connecting the Projector	17
Connecting a Computer	17
Connecting a VCR	19
Projecting	20
Turning Off the Power	22

Convenient Functions

Selecting the Menu Language	23
Security Lock	24
Other Functions	26
Direct Power On/Off Function ...	26
Off & Go Function	26
Effective Tools for Your Presentation	26
Controlling the Computer Using a Presentation Tool, RM-PJPK1	

(not supplied) (When Using the Network Presentation Function)	26
---	----

Adjustments and Settings Using a Menu

Using a MENU	27
The Picture Menu	29
The Screen Menu	31
About the Preset Memory No.	32
The Setup Menu	33
The Function Menu	35
The Installation Menu	37
The Information Menu	39

Maintenance

Replacing the Lamp	41
Cleaning the Air Filter	43

Others

Troubleshooting	44
Messages List	47
Specifications	48
Dimensions	54
Index	57

Precautions

Warning

The Installation Manual contained in the CD-ROM is for dealers.

If customers perform the installation described in this manual, an accident may occur, causing serious injury. Never install it by yourself. For installation, be sure to consult with a Sony dealer.

On safety

- Check that the operating voltage of your unit is identical with the voltage of your local power supply. If voltage adaptation is required, consult with qualified Sony personnel.
- Should any liquid or solid object fall into the cabinet, unplug the unit and have it checked by qualified Sony personnel before operating it further.
- Unplug the unit from the wall outlet if it is not to be used for several days.
- To disconnect the cord, pull it out by the plug. Never pull the cord itself.
- The wall outlet should be near the unit and easily accessible.
- The unit is not disconnected from the AC power source (mains) as long as it is connected to the wall outlet, even if the unit itself has been turned off.
- Do not look into the lens while the lamp is on.
- Do not place your hand or objects near the ventilation holes — the air coming out is hot.
- Be careful not to catch your fingers by the adjuster when you adjust the height of the unit. Do not push hard on the top of the unit with the adjuster out.
- Be sure to grasp both sides of the unit with both hands when carrying the unit.
- When you set the angle of projection to more than $\pm 20^\circ$, read the Installation Manual for Dealers thoroughly for safe installation.

On illumination

- To obtain the best picture, the front of the screen should not be exposed to direct lighting or sunlight.
- Ceiling-mounted spot lighting is recommended. Use a cover over fluorescent lamps to avoid lowering the contrast ratio.
- Cover any windows that face the screen with opaque draperies.
- It is desirable to install the unit in a room where floor and walls are not of light-reflecting material. If the floor and walls are of reflecting material, it is recommended that the carpet and wall paper be changed to a dark color.

On preventing internal heat build-up

The unit is equipped with ventilation holes (intake) at the bottom and ventilation holes (exhaust) at the rear. Do not block or place anything near these holes, or internal heat build-up may occur, causing picture degradation or damage to the unit.

On cleaning

- To keep the cabinet looking new, periodically clean it with a soft cloth. Stubborn stains may be removed with a cloth lightly dampened with a mild detergent solution. Never use strong solvents, such as thinner, benzene, or abrasive cleansers, since these will damage the cabinet.
- Avoid touching the lens. To remove dust on the lens, use a soft dry cloth. Do not use a damp cloth, detergent solution, or thinner.
- Clean the filter whenever you replace the lamp.

On repacking

Save the original shipping carton and packing material; they will come in handy if you ever have to ship your unit. For maximum protection, repack your unit as it was originally packed at the factory.

On LCD projector

The LCD projector is manufactured using high-precision technology. You may, however, see tiny black points and/or bright points (red, blue, or green) that continuously appear on the LCD projector. This is a normal result of the manufacturing process and does not indicate a malfunction.

Also, when you use multiple LCD projectors to project onto a screen, even if they are of the same model, the color reproduction among projectors may vary, since color balance may be set differently from one projector to the next.

Notes on Installation and Usage

Unsuitable Installation

Do not install the unit in the following situations. **These installations may cause malfunction or damage** to the unit.

Poorly ventilated

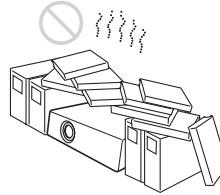

- Allow adequate air circulation to prevent internal heat build-up. Do not place the unit on surfaces (rugs, blankets, etc.) or near materials (curtains, draperies) that may block the ventilation holes.
- When the internal heat builds up due to the block-up, the temperature sensor will function with the message “High temp.! Lamp off in 1 min.” The power will be turned off automatically after one minute.
- Leave space of more than 30 cm (11 ⁷/₈ inches) around the unit.
- Be careful that the ventilation holes may inhale tininess such as a piece of paper.

Highly heated and humid



- Avoid installing the unit in a location where the temperature or humidity is very high, or temperature is very low.
- To avoid moisture condensation, do not install the unit in a location where the temperature may rise rapidly.

Subject to direct cool or warm air from an air-conditioner

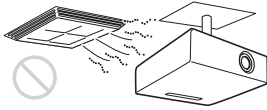

Installing in such a location may cause malfunction of the unit due to moisture condensation or rise in temperature.

Near a heat or smoke sensor

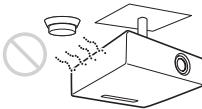

Malfunction of the sensor may be caused.

Very dusty, extremely smoky

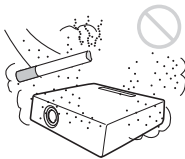

Avoid installing the unit in a very dusty or extremely smoky environment. Otherwise, the air filter will become obstructed, and this may cause a malfunction of the unit or damage it. Dust preventing the air passing through the filter may cause a rise in the internal temperature of the unit. Clean the air filter whenever you replace the lamp.

Usage in High Altitude

When using the unit at an altitude of 1,500 m or higher, set the “High Altitude Mode” to “On” in the Setup menu. Failing to set this mode when using the unit at high altitudes could have adverse effects, such as reducing the reliability of certain components.

Note on the screen

When using a screen with an uneven surface, stripes pattern may rarely appear on the screen depending on the distance between the screen and the unit or the zooming

magnifications. This is not a malfunction of the unit.

Unsuitable Conditions

Do not use the unit under the following conditions.

Do not topple the unit

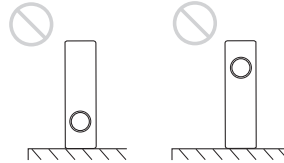

Avoid using as the unit topples over on its side. It may cause malfunction.

Do not tilt right/left

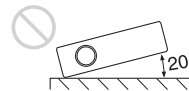

Avoid using as the unit tilts more than 20 degrees. Do not install the unit other than on the floor or ceiling. These installations may cause malfunction.

Do not block the ventilation holes



Avoid using something to cover over the ventilation holes (exhaust/intake); otherwise, the internal heat may build up.

Do not place a blocking object just in front of the lens

Do not place any object just in front of the lens that may block the light during projection. Heat from the light may damage the object. Use the PIC MUTING key on the Remote Commander to cut off the picture.

About the Supplied Manuals

The following manuals and softwares are supplied with the projector.

On Macintosh system, you can read only the Operating Instructions and Installation Manual for Dealers.

Manuals

Safety Regulations (separately printed manual)

This manual describes important notes and cautions to which you have to pay attention when handling and using this projector.

Quick Reference Manual (separately printed manual)

This manual describes basic operations for projecting pictures after you have made the required connections.

Operating Instructions (on the CD-ROM) (this manual)

This Operating Instructions describes the setup and operations of this projector.

Operating Instructions for Network (on the CD-ROM)

This Operating Instructions describes how to set up and operate the network presentation.

Installation Manual for Dealers (on the CD-ROM)

This manual describes the information for mounting the optional lenses on the projector and installing the projector.

Note

You must have Adobe Acrobat Reader 5.0 or higher is installed to read the Operating Instructions stored on the CD-ROM.

Software (on the CD-ROM)

Projector Station for Air Shot Version 2 (Version 2.xx) (Japanese and English only)

This is an application software for transmitting data from a computer to the projector.

Features

High brightness and high picture performance

High brightness

Sony's unique optical system with the new-generation LCD panel "BrightEra" incorporating a newly developed inorganic alignment, allows a light output of 4000 lumen (VPL-FE40/FX40)/5200 lumen (VPL-FX41).

High resolution

VPL-FE40: Three 0.79-inch SXGA+ panels with 1,470,000 pixels provide a resolution of 1400 × 1050 (horizontal/vertical) for RGB input.

VPL-FX40/FX41: Three 0.79-inch XGA panels with 786,432 pixels provide a resolution of 1024 × 768 (horizontal/vertical) for RGB input.

High picture performance

DDE (Dynamic Detail Enhancer) technology enables conversion of interlace format video signals to progressive format, allowing you to obtain a detailed picture. The technology also reproduces the film sources in 2-3 Pull-Down format with smooth picture movement. 12-bit 3D Digital Gamma Correction or 3D Digital Comb Filter for good picture uniformity is also provided.

Convenient and flexible setup

Power zoom/power focus and horizontal/vertical lens shift function

The projector is equipped with a 1.3-times power zoom, power focus lens and horizontal/vertical lens shift function which allows you to change the size of the projected image with the Remote Commander operated away from the projector.

* The optional lens VPLL-1008 can adjust the focus manually.

Also, optional lenses are available for the projector, depending on your setup condition.

* The optional lenses available for VPL-FE40, VPL-FX40 and VPL-FX41 equipped with a standard lens only.

Center positioned lens

The projector is designed to locate the lens in the center of the projector. This enables easy setup, as the lens center aligns with the center of the screen.

Tilt installation (at front and rear)

You can install the projector by tilting it 90 degrees at the rear or 90 degrees in front. You can use a mirror for rear projection.

Direct Power On/Power Off function

The AC power for the entire system can be turned on and off by means of a breaker or other switch.

ID function

The function allows you to adjust or control each projector individually with one Remote Commander when you use two or more projectors in one room.

Simple maintenance

Even when the projector is mounted on the ceiling you can change the lamp or clean the air filter easily because the replacement lamp is located at the side of the projector and the air filter is located at the front of the projector.

Clean the air filter whenever you replace the lamp.

System expandability using a network

Connection to a LAN allows you to turn the projector on/off away from the installation location via a Web browser or to obtain projector status information such as the lamp timer.

Also, this projector enables the sending of mail that contains messages on the time for replacement of the projector lamp, error occurrences, etc., to mail addresses that have been specified. Also, this projector is available for SNMP.

Multi scan compatibility

HDMI and 5BNC connectors

The projector has the HDMI (High-Definition Multimedia Interface) connector, digital input connector, which allows you to connect to the digital RGB equipment equipped with the HDMI output. The 5BNC input connectors allow you to connect to equipment output high-resolution signals and to connect to a computer from a long distance.

Accepts various input signals

The projector accepts video signals of the composite, S video and component, and can also display VGA, SVGA, XGA, WXGA, SXGA, SXGA+ and UXGA (60 Hz) signals.

Network presentation

Any image of a computer, if it is connected to a LAN by wired or wireless connection, can be projected by connecting a network cable to the NETWORK connector (RJ-45) of the projector.

For details, refer to the "Operating Instructions for Network."

Other Convenient Functions

- Low fan noise makes your presentation comfortable
- Twin stack installation
- Security lock
- Panel key lock
- Easy-to-use Remote Commander that can select the input source directly
- On-screen menu in 16 languages
- Picture/Audio muting
- Freeze
- Lamp mode switching function
- Low power consumption in standby

About Trademarks

- Adobe Acrobat is a trademark of Adobe Systems Incorporated.
- Windows is a registered trademark of Microsoft Corporation in the United States and/or other countries.
- Kensington is a registered trademark of Kensington Technology Group.

- Macintosh is a registered trademark of Apple Computer, Inc.
- VESA is a registered trademark of the Video Electronics Standard Association.
- Display Data Channel is a trademark of the Video Electronics Standard Association.
- HDMI, HDMI logo and High-Definition Multimedia Interface are trademarks or registered trademarks of HDMI Licensing LLC.
- Air Shot is a trademark of Sony corporation.
- “BrightEra” is a trademark of Sony corporation.
- All other trademarks and registered trademarks are trademarks or registered trademarks of their respective holders. In this manual, ™ and © marks are not specified.

Unless otherwise specified in notes, the VPL-FE40 described in this manual refers to both the VPL-FE40 and VPL-FE40L, the VPL-FX40 refers to both the VPL-FX40 and VPL-FX40L, and the VPL-FX41 refers to both the VPL-FX41 and VPL-FX41L.

Location and Function of Controls

Top/Front/Side

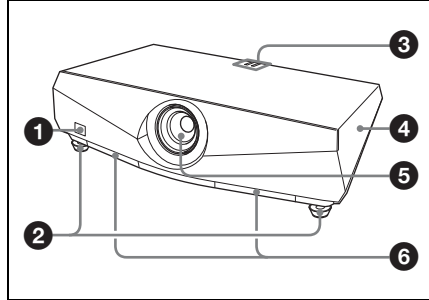

Rear/Side/Bottom

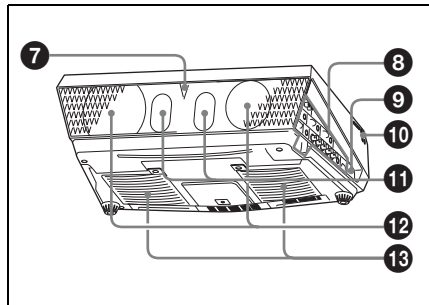

1 Front remote control detector

2 Adjusters

Turn the appropriate adjuster to the right or left for minor tilt adjustment of the projected picture.

3 Indicator

For details, see “Control Panel” on page 11.

4 Lamp cover

5 Lens

Remove the lens cap before projection. The lens is not supplied with the VPL-FE40L/FX40L/FX41L.

6 Air filter covers

The air filter of VPL-FX41 can be set on one side only.

Note

To maintain optimal performance, **clean the air filter whenever you replace the lamp.**

For details, see “Cleaning the Air Filter” on page 43.

7 Rear remote control detector

8 Connector Panel

For details, see “Connector Panel” on page 12.

9 Security lock

Connects to an optional security cable (from Kensington).

Web page address:
<http://www.kensington.com/>

10 Control panel

For details, see “Control Panel” on page 11.

11 Speakers

12 Ventilation holes (exhaust)

13 Ventilation holes (intake)

The ventilation hole (intake) of VPL-FX41 is on one side only.

Notes

- Do not place anything near the ventilation holes as this may cause internal heat build-up.
- Do not place your hand near the ventilation holes as this may cause injury.

Control Panel

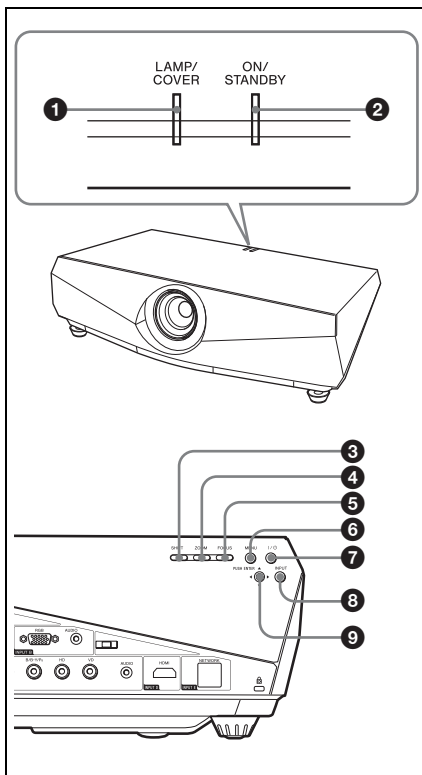

1 LAMP/COVER indicators

Flashes in orange under the following conditions:

- A reception rate of 2 flashes when the lamp cover or air filter cover is not secured firmly.
- A reception rate of 3 flashes when the lamp has reached the end of its life or reaches a high temperature.

For details, see “Indicators” on page 46.

2 ON/STANDBY indicator

Lights up or flashes under the following conditions:

- Lights in red when the AC power cord is plugged into a wall outlet. Once the projector is in standby mode, you can turn it on with the I/O key.

- Flashes in red when the internal temperature is high or the electrical system has failed.
- Lights in green when the projector is turned on, and when it is ready to operate.
- Flashes in green from the time when the projector is turned on until the projector is ready to operate. Also, flashes in green while the cooling fan is running after the power is turned off with the I/⏻ key. The fan runs for about 90 seconds after the power is turned off.
- Lights in orange when the power saving mode is on.

For details, see “Turning Off the Power” on page 22 and “Indicators” on page 46.

3 SHIFT key

Enters the H/V shift adjustment mode. Next, adjust the vertical/horizontal position of the picture using the arrow keys. Press the ▲ key to move the picture upward. Press the ▼ key to move it downward. Press the ◀ key to move it leftward. Press the ▶ key to move it rightward.

Note

When the optional accessory VPLL-1008 is attached to the projector, do not perform a lens-shift operation after installation, because the projector is installed to align the center point of the screen with that of the lens by a dealer. Otherwise, edges of the picture may be cropped.

4 ZOOM key

Enters the zoom adjustment mode. Next, adjust the picture size using the arrow keys. Press the ▲ or ▶ key to enlarge the picture size, and the ▼ or ◀ key to reduce it.

5 FOCUS key

Enters the focus adjustment mode. Next, adjust the focus using the arrow keys. Press the ▲ or ▶ key to focus on a picture further back, and the ▼ or ◀ key to focus on a picture further forward.

The ZOOM and FOCUS keys cannot be used when you attach the optional lens VPLL-1008 to the projector.

6 MENU key

Displays the on-screen menu. Press again to clear the menu.

7 I/⏻ (On/Standby) key

Turns on the projector when it is in standby mode. When you push this key, the ON/STANDBY indicator flashes in green and then lights in green when the projector is ready to operate.

To turn off the power, press the I/⏻ key twice according to the message or hold the I/⏻ key for about one second.

8 INPUT key

Select the input signal. Each time you press the key the input signal switches.

9 ENTER/▲/▼/◀/▶ (Arrow) keys

Used to enter the settings of items in the menu system, select a menu, or make various adjustments.

Connector Panel

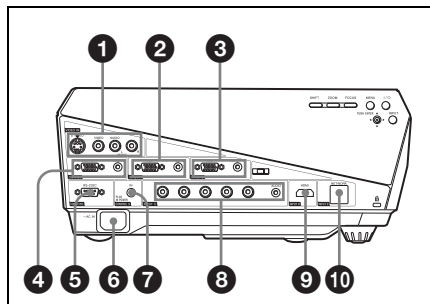

1 VIDEO IN (Video input)

Connects to external video equipment .
S VIDEO (mini DIN 4-pin)

Connects to the S video output (Y/C video output) of video equipment.

VIDEO (phono type)

Connects to the composite video output of video equipment.

AUDIO input L (MONO)/R (phono type)

Connect to the audio output of video equipment. For stereo equipment use both the L and R jacks; for monaural equipment use the L (MONO) jack only.

2/3 INPUT A/INPUT B

Analog RGB connector (HD D-sub 15-pin, female)

Connects to external equipment such as a computer.

Connects to the monitor output of a computer using an optional cable.

AUDIO jack (stereo minijack)

To listen to sound output from a computer, connect via this jack to the audio output of the computer.

For details, see “Connecting a Computer” on page 17 and “Connecting a VCR” on page 19.

4 OUTPUT

MONITOR connector (HD D-sub 15-pin, female)

Connect to the video input connector of the monitor. Outputs signals from the selected channel and computer signals only from among the signals from the INPUT A, INPUT B or INPUT C.

This connector does not output any signals from the INPUT D connector.

AUDIO jack (stereo minijack)

Connects to external active speakers.

The volume of the speakers can be controlled by the VOLUME +/- keys on the Remote Commander.

When INPUT A, INPUT B or INPUT C is selected, the sound input to the AUDIO connector which is for INPUT A, INPUT B or INPUT C is output.

When VIDEO or S VIDEO is selected, the sound input to the AUDIO input connector of VIDEO IN is output.

5 REMOTE

RS-232C connector (D-sub 9-pin, female)

Connects to a computer to operate the projector from the computer.

6 AC IN socket

Connects the supplied AC power cord.

7 CONTROL S IN/PLUG IN POWER (DC 5V output) jack (stereo minijack)

Connects to the control S out jacks of Sony equipment. Connects to the CONTROL S OUT jack on the supplied Remote Commander when using it as a wired Remote Commander. In this case, when a stereo cable is used, you do not need to install batteries in the Remote Commander as the power is supplied from this jack.

8 INPUT C

Analog RGB/Component connectors (R/R-Y/P_R, G/Y, B/B-Y/P_B, HD, VD) (BNC type)

We recommend using this terminal when signals are to be transmitted over greater distance than usual, such as when the projector is suspended from a ceiling. Computer, component (R-Y/Y/B-Y), HDTV or DTV (DTV GBR, DTV YPbPr) signal can be selected.

AUDIO (stereo mini-jack)

Connects to the audio output on a computer.

9 INPUT D

Digital RGB/Component connector (HDMI) (accepts HDCP)

Connects to a video output connector on video equipment or a computer equipped with HDMI/DVI output connector (digital).

10 INPUT E

NETWORK connector (RJ-45)

Connects to the LAN cable when the network function is in use.

CAUTION

For safety, do not connect the connector for peripheral device wiring that might have excessive voltage to this port. Follow the instructions for this port.

Remote Commander

The keys that have the same names as those on the control panel function identically.

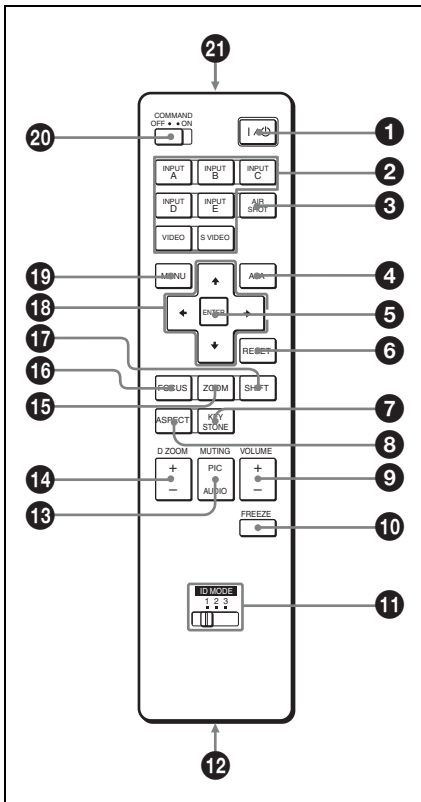

1 I/⏻ (On/Standby) key

2 INPUT A/B/C/D/E keys

Selects the input signal output from the connector of the same name as those of the Remote Commander.

3 AIR SHOT key

Displays the Network Presentation Home.

For details, see Operating Instructions for Network (stored on the CD-ROM).

4 APA (Auto Pixel Alignment) key

Automatically adjusts a picture to its clearest while a signal is input from a computer.

For details, see “APA” in “The Screen Menu” on page 31.

5 ENTER key

6 RESET key

Resets the value of an item to its factory preset value. This key functions when a setting item is displayed on the screen.

7 KEYSTONE (Vertical trapezoidal distortion correction) key

Adjusts the vertical trapezoidal distortion of the image manually. When you press this key, the V Keystone menu is displayed. Use the arrow keys (↑/↓/←/→) for adjustment.

8 ASPECT key

Select the aspect ratio of the picture. Each time you press this key the aspect ratio changes according to the input signals.

9 VOLUME +/- keys

10 FREEZE key

Freezes the projected picture. To cancel the frozen picture, press the key again.

11 ID MODE 1/2/3 keys

When you apply the same identification number as the projector to a Remote Commander you can easily adjust or control each projector with a Remote Commander whenever you use two or more projectors in one room.

For details, see “ID Mode” in the Installation menu on page 38.

12 CONTROL S OUT jack (stereo mini-jack)

Connects to the CONTROL S IN jack on the projector with the connecting cable (not supplied) when using the Remote Commander as a wired one. In this case you do not need to install the batteries since the power is supplied via the CONTROL S IN jack on the projector.

13 MUTING keys

Cut off the picture and sound.

- **PIC:** Cuts off the picture. Press again to restore the picture.
- **AUDIO:** Press to temporarily cut the audio output from the speaker or audio signal from the AUDIO jack of OUTPUT. Press again or press the VOLUME+ key to restore the sound.

14 D ZOOM (Digital Zoom) +/- key

This function is not provided in this projector.

15 ZOOM +/- keys

Adjusts the picture size.

16 FOCUS +/- keys

Adjusts the picture focus.

17 SHIFT +/- keys

Adjusts the vertical/horizontal position of the picture.

18 ↑/↓/←/→ keys (Arrow)

Used to enter the settings of items in the menu or make adjustment for zoom, focus or shift.

19 MENU key**20 COMMAND ON/OFF switch**

When this switch is set to OFF, the keys on the Remote Commander do not function. This saves battery power.

21 Infrared transmitter

Be sure to install the battery from the ⊖ side.

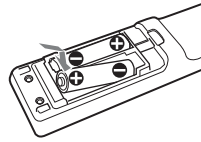
**2** Replace the lid.**Notes on Remote Commander operation**

- Make sure that nothing obstructs the infrared beam between the Remote Commander and the remote control detector on the projector. Direct the Remote Commander toward the front or rear remote control detector.
- The operation range is limited. The shorter the distance between the Remote Commander and the projector is, the wider the angle within which the commander can control the projector becomes.

CAUTION

Danger of explosion if battery is incorrectly replaced.

Replace only with the same or equivalent type recommended by the manufacturer.

When you dispose of the battery, you must obey the law in the relative area or country.

To install batteries

- 1 Push and slide the lid to open it, then install the two size AA (R6) batteries (supplied) with the correct polarity.

While pressing the lid, slide it.

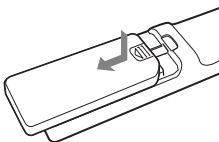

Installing the Projector

The following table gives an example of installing the standard lens supplied with VPL-FE40/VPL-FX40/VPL-FX41.

For details on installation, ceiling installation or when you use an optional lens, be sure to refer to the operating instructions of “Installation Manual for Dealers”.

The distance between the lens and the screen varies depending on the size of the screen. Use the following table as a guide.

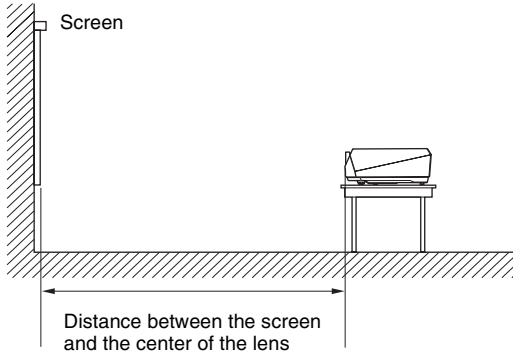

Unit: m (feet)

Screen size (inches)	40	60	80	100	120	150	200	300	400	500	600
Minimum Distance	1.5 (4.9)	2.3 (7.4)	3.0 (9.9)	3.8 (12.5)	4.6 (15.0)	5.7 (18.8)	7.7 (25.2)	11.6 (37.9)	15.4 (50.6)	19.3 (63.3)	23.2 (76.0)
Maximum Distance	1.9 (6.2)	2.9 (9.5)	3.9 (12.7)	4.8 (15.9)	5.8 (19.1)	7.3 (23.9)	9.7 (32.0)	14.6 (48.0)	19.5 (64.1)	24.4 (80.2)	29.4 (96.3)

There may be a slight difference between the actual value and the design value shown in the table above.

For details on installation, See “Installation Manual for Dealers” on the CD-ROM.

Connecting the Projector

When you connect the projector, make sure to:

- Turn off all equipment before making any connections.
- Use the proper cables for each connection.
- Insert the cable plugs firmly; loose connections may increase noise and reduce performance of picture signals. When pulling out a cable, be sure to pull it out by the plug, not the cable itself.

When connecting to a LAN using a LAN cable, see “Operating Instructions for Network” stored on the CD-ROM.

Connecting a Computer

This section describes how to connect the projector to a computer. For more information, refer to the computer’s instruction manual.

To connect a computer (Analog)

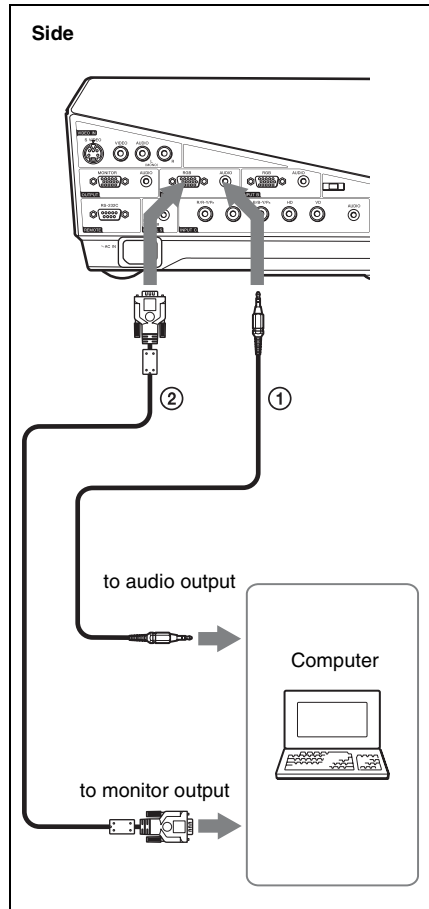

- ① Stereo audio connecting cable (not supplied)
(Use a no-resistance cable.)
- ② HD D-sub 15-pin cable (not supplied)

Notes

- The projector accepts VGA, SVGA, XGA, WXGA, SXGA, SXGA+ and UXGA signals. However, we recommend that you set the output mode of your computer to SXGA+ (VPL-FE40) or XGA (VPL-FX40/FX41) mode for the external monitor.
- If you set your computer, such as a notebook computer, to output the signal to both your computer’s display and the external monitor, the picture of the external monitor may not appear properly. Set your computer to output the signal to only the external monitor.

For details, refer to the operating instructions supplied with your computer.

Note

To connect a Macintosh computer equipped with a video output connector of a type having two rows of pins, use a commercially available plug adaptor.

To connect a computer (Digital) or video equipment (Digital)

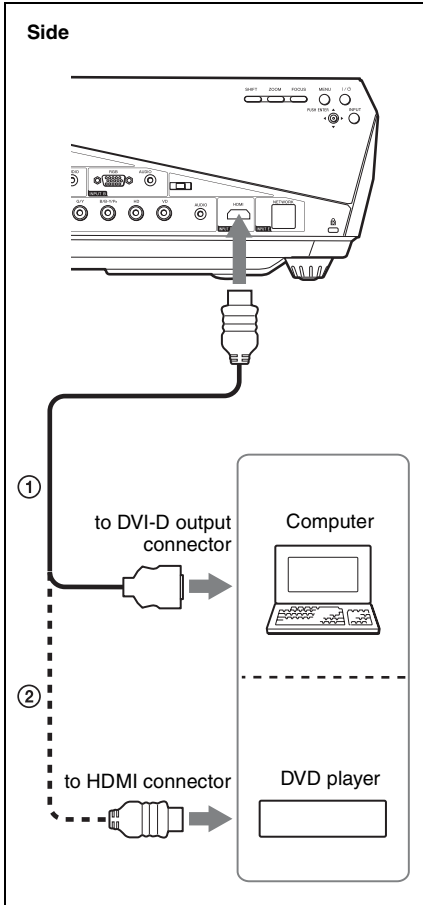

- ① HDMI-DVI-D cable (not supplied)
- ② HDMI cable (not supplied)

Note

Be sure to use the HDMI cable with an HDMI logo.

The HDMI connector of this projector is not compatible with DSD (Direct Stream Digital) Signal or CEC (Consumer Electronics control) Signal.

To attach the HDMI cable

Fix the cable to the cable tie holder next to the HDMI cable using a commercially available cable tie as in the illustration.

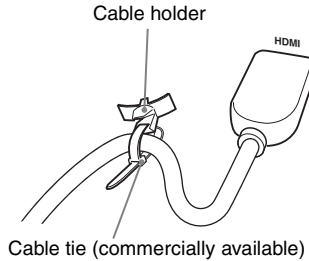

* Use a cable tie of less than 1.9 mm x 3.8 mm thickness.

Connecting a VCR

This section describes how to connect the projector to a VCR.

For more information, refer to the instruction manuals of the equipment you are connecting.

To connect to a video or S video output connector

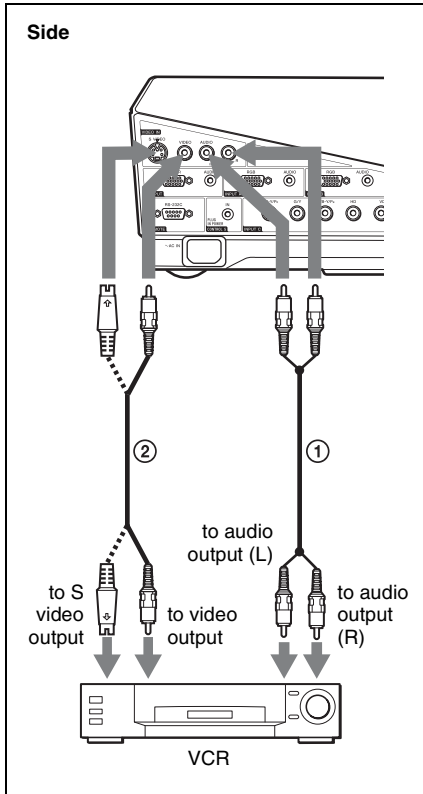

- ① Audio connecting cable (not supplied)
For stereo equipment use both the L and R jacks.
For monaural equipment use the L (MONO) jack only.
- ② Video cable (not supplied) or S-Video cable (not supplied)

To connect to a video GBR/ Component output connector

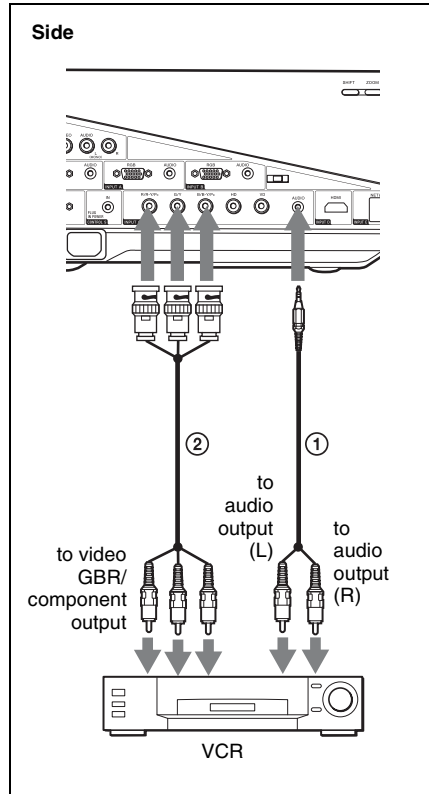

- ① Stereo audio connecting cable (not supplied)
(Use a no-resistance cable.)
- ② BNC cable (not supplied)

Note

Set the aspect ratio using “Aspect” on the Screen menu according to the input signal.

Projecting

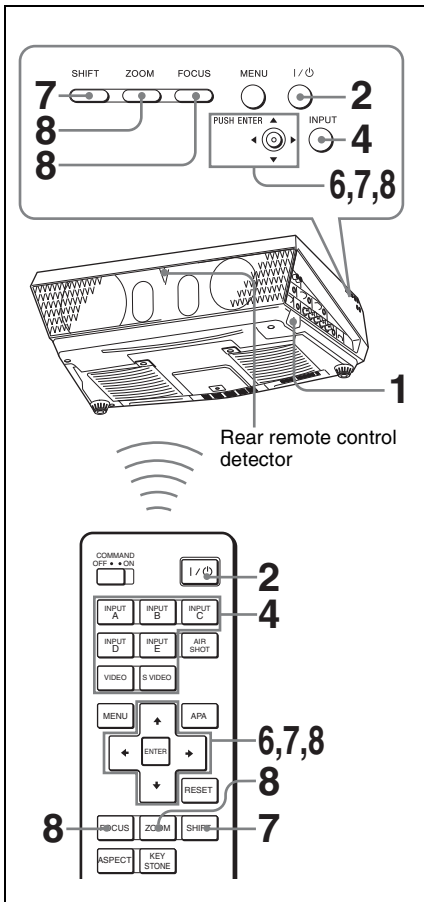

- 1 Plug the AC power cord into a wall outlet, then connect all equipment. The ON/STANDBY indicator lights in red and the projector goes into standby mode.
- 2 Press the I/⏻ key. The ON/STANDBY indicator flashes in green, and then lights in green.
- 3 Turn on the equipment connected to the projector.

- 4 Press the INPUT key to select the input source.

You can select directly the input signal you want to project by pressing one key from among INPUT A, B, C, D or E on the Remote Commander.

Each time you press the INPUT key on the control panel, the input signal switches as follows:

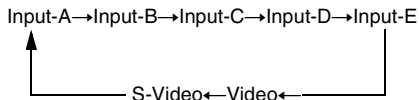

To input from	Press INPUT to display
Computer, etc. connected to the INPUT A connector	Input-A
Computer, etc. connected to the INPUT B connector	Input-B
Computer/VCR, etc. connected to INPUT C connector	Input-C
Computer/VCR, etc. connected to INPUT D (Digital) connector	Input-D
Computer connected to LAN to use the network presentation function	Input-E
Video equipment connected to the VIDEO input connector	Video
Video equipment connected to the S VIDEO input connector	S-Video

Smart APA (Auto Pixel Alignment) adjusts the picture of the connected equipment so that it is projected clearly.





Notes

- If “Auto Input Search” is set to “On,” the projector searches for the signals from the connected equipment and displays the input channel where the input signals are found.

For details, see “Auto Input Search” in the Function menu on page 35.

- The Smart APA feature is effective for the input (analog) signal from a computer only.
(It is not effective for digital computer signal.)

5 Switch the equipment connected to output to the projector.

Depending on the type of your computer, for example a notebook, or an all-in-one LCD type, you may have to switch the computer to output to the projector by pressing certain keys (e.g., , , , , etc.), or by changing your computer's settings.

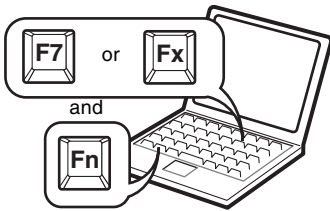









Note

The key used for switching the computer to output to the projector varies depending on the type of computer.

6 Adjust the upper, lower, left or right position of the picture using the /// key while pressing the SHIFT key.

7 Adjust the size of the picture and the focus.

Press the FOCUS key and adjust the focus using the /// keys.
Press the ZOOM key and adjust the size of the picture using the /// keys.

Note

The VPLL-1008 does not have the zoom function. To adjust the focus of the picture, turn the lens ring.

To adjust the tilt of the installation surface

If the projector is installed on an uneven surface, use the adjusters to keep the projector level.

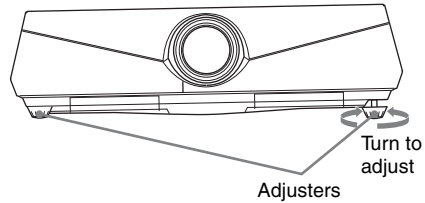

Notes

- Be careful not to let the projector down on your fingers.
- Do not push hard on the top of the projector with the adjuster extended.
It may cause a malfunction.

Turning Off the Power

- 1 Press the I/⏻ key.
“POWER OFF? Please press I/⏻ key again.” appears to confirm that you want to turn off the power.

Note

The message disappears if you press any key other than the I/⏻ key, or if you do not press any key for approximately five seconds.

- 2 Press the I/⏻ key again.
The ON/STANDBY indicator flashes in green and the fan continues to run to reduce the internal heat. Also, the ON/STANDBY indicator flashes quickly. During this time, you will not be able to light up the ON/STANDBY indicator again with the I/⏻ key.
- 3 Unplug the AC power cord from the wall outlet after the fan stops running and the ON/STANDBY indicator lights in red. (except when using the Direct Power On/Off function and the Off & Go Function.)

When you cannot confirm the on-screen message

When you cannot confirm the on-screen message under certain conditions, you can turn off the power by holding the I/⏻ key for about one second instead of the steps 1 and 2 above.

Note

The internal circuitry of the Off & Go and Direct Power On/Off functions may cause the fan to continue to operate for a short time even after the I/⏻ key is pressed to turn off the power and the ON/STANDBY indicator changes to red.

► **Convenient Functions**

Selecting the Menu Language

You can select one of sixteen languages for displaying the menu and other on-screen displays. The factory setting is English. To change the menu language, proceed as follows:

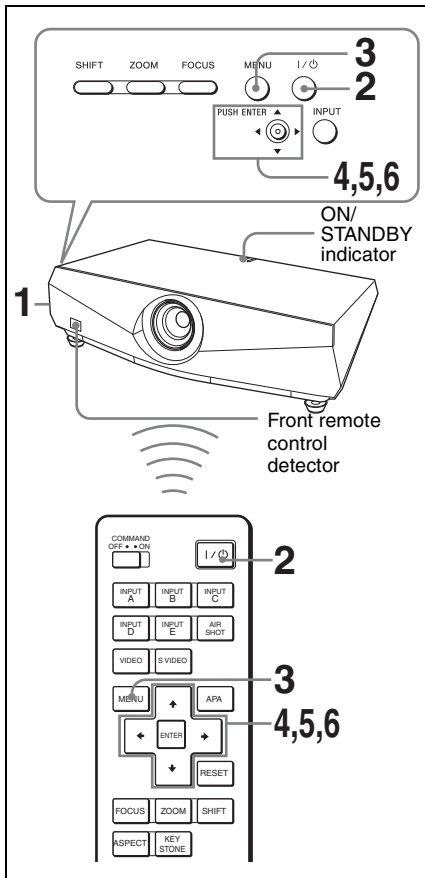

1 Plug the AC power cord into a wall outlet.

2 Press the I/⏻ key to turn on the projector.

3 Press the MENU key.

The menu appears.

The menu currently selected is shown as a yellow button.

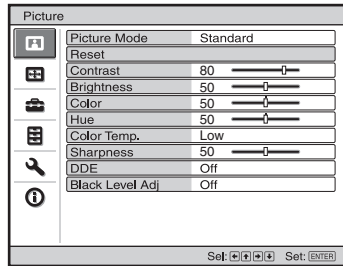

4 Press the ↑ or ↓ key to select the (Setup) menu, then press the → or ENTER key.

The selected menu appears.

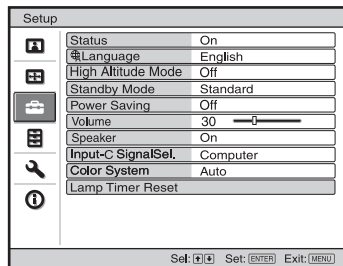

5 Press the ↑ or ↓ key to select “Language,” then press the → or ENTER key.



6 Press the ↑, ↓, ← or → key to select a language, then press the ENTER key.

The menu changes to the selected language.

To clear the menu

Press the MENU key.

The menu disappears automatically if a key is not pressed for one minute.

Security Lock

The projector is equipped with a security lock function. When you turn the power of the projector on, you are required to input the previously set password. If you do not input the correct password, you will not be able to project the picture.

Notes

- When the security lock becomes effective, you are required to input the password only when you turn the projector on after disconnecting or reconnecting the cable.
- You will not be able to use the projector if you forget your password and the password administrator is not available. Be please aware that using the security lock can prevent valid usage in such cases.

To use the security lock

- 1 Press the MENU key and then, on the Function menu, turn on the “Security Lock” setting.
- 2 Enter the password.
Use the MENU, $\uparrow/\downarrow/\leftarrow/\rightarrow$, and ENTER keys to enter the four-digit password. (The default initial password setting is “ENTER, ENTER, ENTER, ENTER.” After this is entered you can put in your own password. Therefore, when you use this function for the first time, please input “ENTER” four times.)

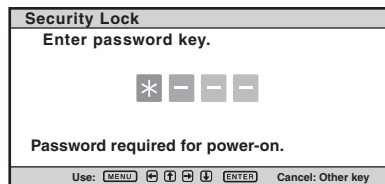

Next, the screen for entering the new password is displayed. (Enter the password on this screen even if you want to keep the current password.)

Enter the password on this screen.



Note

If you call the customer service center because you have forgotten the password, you will need to be able to verify the projector's serial number and your identity. (This process may differ in other countries/regions.) Once your identity has been confirmed, we will provide you with the password.

3 Enter the password again to confirm.



When “Security Lock enabled!” is displayed on the menu screen, the setting for security lock is completed.

If “Invalid Password!” is displayed on the menu screen, perform this procedure again from step 1.

4 Turn the main power off and disconnect the AC power cord.

The security lock is set to on, then it becomes effective. The screen used for entering the password is displayed when the power is turned on the next time.

Security certification

When the password screen is displayed, enter the password that was set. If you fail to enter the correct password after three tries, the projector cannot be used. In this case, press the I/O key to turn off the power.

To cancel the security lock

1 Press the MENU key, then turn off the “Security Lock” setting in the Function menu.

2 Enter the password.
Enter the password that was set.

Other Functions

Direct Power On/Off Function

If you will be using a circuit breaker to turn the power for the entire system on and off, set the direct power on function to “On.” You can turn the power on/off without pressing the power key on the projector. After the power is turned off, the internal circuitry will cause the fan to automatically operate for a certain time.

Note

The fan does not turn in the VPL-FX41. However, the Direct Power On/Off function has the same performance.

Off & Go Function

If you are leaving the conference room immediately, turn the projector off. Then you may unplug the AC power cord. It does not matter. After the AC power cord is unplugged, the fan runs for a certain time automatically.

Notes

- The fan does not turn in the VPL-FX41. However, the Off & Go function has the same performance.
- You need more than 15 minutes for a charge power supply. If the projector has been on for less than 15 minutes, the fan might not turn enough as a result of inadequate charging. If the projector has been on for a short time, unplug the AC power cord from the wall outlet after the power off and the ON/STANDBY indicator lights in red (except with the VPL-FX41).
- When the power is turned on soon after it has been turned off, it may take some time until the lamp will light on.

Effective Tools for Your Presentation

To freeze the image projected (Freeze function)

Press the FREEZE key. “Freeze” appears when the key is pressed. This function works when a signal from a computer is input. To restore the original screen, press the FREEZE key again.

Controlling the Computer Using a Presentation Tool, RM-PJK1 (not supplied) (When Using the Network Presentation Function)

When you are using the network presentation function to project the picture from a computer, you can perform some operations for a slide show using a presentation tool (not supplied). The following keys on the presentation tool are usable.

Key	Function
LASER	Emits a laser beam.*
⇄ SLIDE ⇄	Changes the slides in the forward/backward direction.
B	Displays/cancels a black screen during the slide show.

* Even if the network presentation function is not used, the LASER key can be used.

Notes

- If there is any obstruction between the presentation tool and the remote control detector on the projector, the presentation tool may not function properly.
- A black screen may not be displayed even if you press the “B” key depending on the operating system (OS) of the language of your computer.
- When you use the presentation tool, set “ID Mode” in the Installation menu to “All” or “1.”

Using a MENU

The projector is equipped with an on-screen menu for making various adjustments and settings. Some of the adjustable/setting items are displayed in a pop-up menu, in a setting menu or adjustment menu with no main menu, or in the next menu window. If you select an item name followed by an arrow (▶), the next menu window with the setting items appears.

To change the on-screen menu language, see “Selecting the Menu Language” on page 23.

Display items

Input signal indicator



Input signal indicator

Shows the selected input channel. X (▶) is displayed when no signal is input. You can hide this indicator using “Status” on the Setup menu.

- 1 Press the MENU key.
The menu appears.

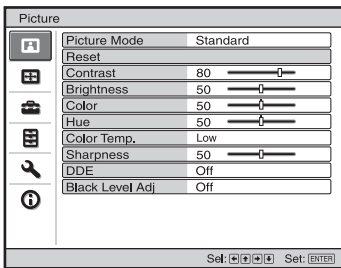

- 2 Use the ↑ or ↓ key to select a menu, then press the → or ENTER key.
The items that can be set or adjusted with the selected menu appear. The item presently selected is shown in yellow.

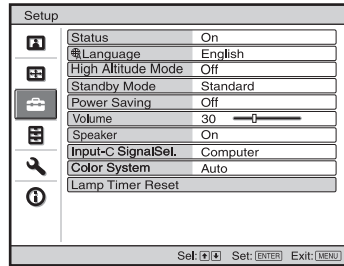

- 3 Select an item.
Use the ↑ or ↓ key to select the item, then press the → or ENTER key.
The setting items are displayed in a pop-up menu, in a setting menu, in an adjustment menu or in the next menu window.

Pop-up menu

Setting items

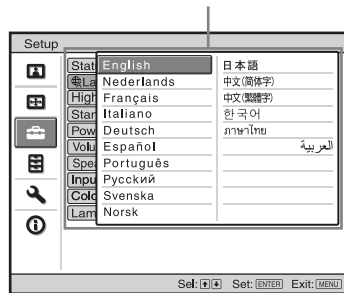

Setting menu

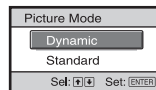

Adjustment menu



Next menu window

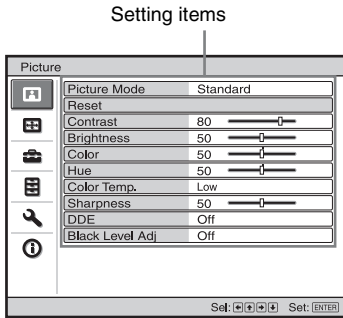

4 Make the setting or adjustment of an item.

• When changing the adjustment level:

To increase the number, press the **↑** or **→** key.

To decrease the number, press the **↓** or **←** key.

Press the ENTER key to restore the previous screen.

• When changing the setting:

Press the **↑** or **↓** key to change the setting.

Press the ENTER key to restore the previous screen.

You can restore the previous screen using **←** depending on the selected item.

To clear the menu

Press the MENU key.

The menu disappears automatically if a key is not pressed for one minute.

To reset items that have been adjusted

To reset the setting of the items, there are the following two ways.

- Select “Reset” in the Picture menu.

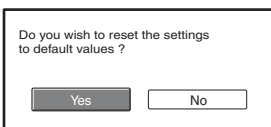

Select “OK” when the screen display appears. The following settings are reset to their factory preset values:

The items that can be reset are as follows: “Contrast,” “Brightness,” “Color,” “Hue,” “Color Temp.,” “Sharpness,” “DDE,” “Black Level Adj.,” “V key stone” and “Gamma Mode” in the Picture menu.

- Press the RESET key on the Remote Commander.

To reset the value of an item back to its factory preset value, press the RESET key while a setting item is displayed on the screen.

Unadjustable items

The adjustable items are limited depending on the input signals. The items that cannot be adjusted or set do not appear in the menu.

For details, see page 39.

Storage of the settings

The settings are automatically stored in the projector memory.

If no signal is input

If there is no input signal, “Cannot adjust this item.” appears on the screen.

The Picture Menu

The Picture menu is used for adjusting the picture. Items that can be adjusted or set depend on the kind of input signals.

For details, see “Input signals and adjustable/setting items” on page 39.

When the video signal is input

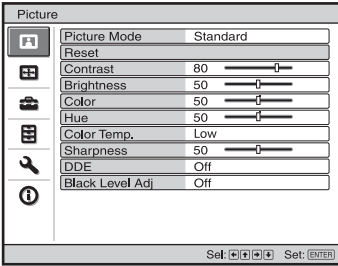

When the signal is input from a computer

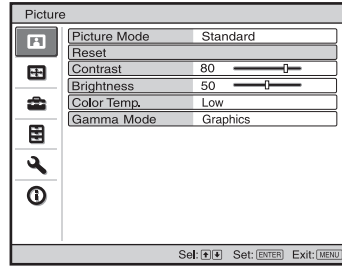

Setting items	Functions	Initial setting
Picture Mode	Selects the picture mode. <ul style="list-style-type: none"> • Dynamic: Emphasizes the contrast to produce a “dynamic” picture. • Standard: Normally select this setting. If the picture has roughness with the “Dynamic” setting, this setting reduces the roughness. 	Standard
Reset	The following settings are initialized to their factory preset values: “Contrast,” “Brightness,” “Color,” “Hue,” “Color Temp,” “Sharpness,” “DDE,” “Black Level Adj.,” and “Gamma Mode” in the Picture Mode.	–
Contrast	Adjusts the white area of pictures (white level). The higher the setting, the greater the contrast. The lower the setting, the lower the contrast.	80
Brightness	Adjusts the brightness of the picture. The higher the setting, the brighter the picture. The lower the setting, the darker the picture.	50
Color	Adjusts the intensity of the color density. The higher the setting, the greater the intensity. The lower the setting, the lower the intensity.	50
Hue	Adjusts the color tone. The higher the setting, the more greenish the picture becomes. The lower the setting, the more reddish the picture becomes.	50
Color Temp.	Adjusts the color temperature. <ul style="list-style-type: none"> • High: Gives white colors a blue tint. • Low: Gives white colors a red tint. 	Low
Sharpness	Sharpens the outline of the picture, or reduces the noise. The higher the setting, the sharper the picture. The lower the setting, the softer the picture, thus reducing the noise.	50

Setting items	Functions	Initial setting
DDE (Dynamic Detail Enhancer)	<p>According to the film source you have selected, make a setting for playback.</p> <ul style="list-style-type: none"> • Film: Normally, select this option. Reproduces the 2-3 Pull-Down film sources with smooth picture movement. When the video signal with a format other than the 2-3 Pull-Down is input, "Progressive" is automatically selected. • Progressive: Converts an interlace format video signal to a progressive format. • Off: Plays a video signal in an interlace format without converting. 	Film
Black Level Adj. (Adjust)	<p>Produces a bolder, dynamic picture. Set according to the input signal source.</p> <ul style="list-style-type: none"> • High: Gives higher emphasis to the black color. • Low: Gives lower emphasis to the black color. • Off: Cancels this feature. 	Off
Gamma Mode	<p>Selects a gamma correction curve.</p> <ul style="list-style-type: none"> • Graphics: Improves the reproduction of halftones. Photos can be reproduced in natural tones. • Text: Contrasts black and white. Suitable for images that contain lots of text. 	Graphics

The Screen Menu

The Screen menu is used to adjust the input signal. You can also adjust the aspect ratio of the picture.

Items that can be adjusted or set depend on the kind of input signals.

For details, see “Input signals and adjustable/setting items” on page 39.

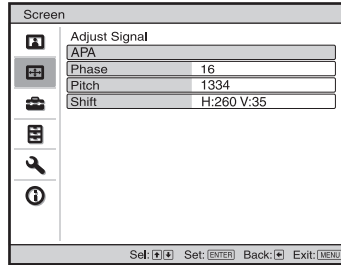
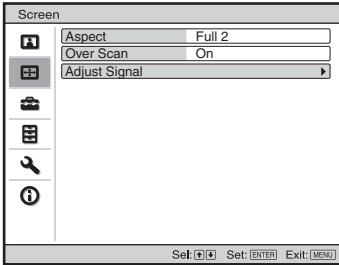

Setting items	Functions	Initial setting
Aspect (When the video signal is input)	<p>You can set the aspect ratio of the picture to be displayed for the current input signal. This item is enabled only when an video signal (preset memory numbers 1 to 15) is input.</p> <ul style="list-style-type: none"> • 4:3 : Select to view a picture with normal 4:3 aspect ratio. • 16:9 : Select to view a picture squeezed. • Zoom: Select to view a squeezed picture with black bands displayed on both sides. 	Set according to the input signal
Aspect (When the PC signal is input)	<p>You can set the aspect ratio of the picture to be displayed for the current input signal. This item is enabled only when an PC signal (preset memory numbers 21 to 56) is input.</p> <ul style="list-style-type: none"> • Full 1: Displays a picture vertically or horizontally to fill the screen without changing the aspect ratio of the original picture. • Full 2: Displays a picture on the whole of the screen. • Normal: Displays the picture while matching one pixel of input picture element to that of the LCD. The picture will be clear but the picture size will be smaller. • 4:3: Makes the aspect ratio 4:3. • 16:9: Makes the aspect ratio 16:9. 	Set according to the input signal
Over Scan	<p>Hides the outline of the picture.</p> <ul style="list-style-type: none"> • On: Hides the outline of the input picture. Select this setting when noise appears along the edge of the picture. • Off: Projects the whole of the input picture. <p><i>To adjust the displayable area within the four directions of the screen, refer to “Blanking” in the Installation menu (page 38)</i></p>	On

Setting items	Functions	Initial setting
Adjust Signal		Set according to the input signal
APA (Auto Pixel Alignment)	Pressing ENTER key automatically adjusts the "Phase," "Pitch" and "Shift" to position the image correctly on a screen.	
Phase	Adjusts the dot phase of the panel and the computer signal. Adjust the picture to the point where it looks clearest.	
Pitch	Adjusts the horizontal size of the picture from a computer. The higher the setting, the wider the picture. The lower the setting, the narrower the picture. Adjust the setting to match the number of dots of the input signal.	
Shift	Adjusts the position of the picture. <ul style="list-style-type: none"> • H: As the setting for H (horizontal) increases, the picture moves to the right, and as the setting decreases, the picture moves to the left. Use ← / → key to adjust the horizontal position. • V: As the setting for V (vertical) increases, the picture moves up, and as the setting decreases, the picture moves down. Use ↑ / ↓ key to adjust the vertical position. 	

Notes

- Note that if the projector is used for profit or for public viewing, modifying the original picture by switching to the aspect mode may constitute an infringement of the rights of authors or producers, which are legally protected.
- For Aspect, "Aspect" itself or a part of the setting items cannot be displayed on the screen according to the input signal. Also, "Full 1" and "Full 2," or "Full 1" and "4:3" may become the same images.

About the Preset Memory No.

This projector has 48 types of preset data for input signals (the preset memory). When a preset signal is input, the projector automatically detects the signal type and recalls the data for the signal from the preset memory to adjust it to an optimum picture. The memory number and signal type of that signal are displayed on the Information menu (See page 39). You can also adjust the preset data through the Screen menu.

This projector has 20 types of user memories for Input-A into which you can save the setting of the adjusted data for an unpreset input signal.

When an unpreset signal is input for the first time, a memory number is displayed as 0. When you adjust the data of the signal using the Screen menu, it will be registered in the

projector. If more than 20 user memory items are registered, the newest memory always overwrites the oldest one.

See the chart on page 51 to find if the signal is registered in the preset memory.

Note

When the aspect ratio of input signal is other than 4:3, a part of the screen is displayed in black.

The Setup Menu

The Setup menu is used for changing the settings of the projector.

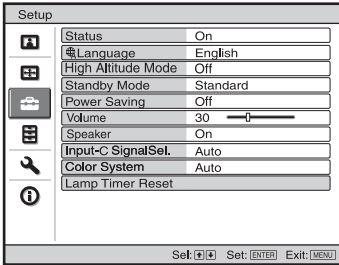

Setting items	Functions	Initial setting
Status	Sets whether or not the on-screen display is displayed. Set to "Off" to turn off the on-screen displays except for the menus, message when turning off the power, and warning messages.	On
Language	Selects the language used in the menu and on-screen displays. Available languages are: English, Dutch, French, Italian, German, Spanish, Portuguese, Russian, Swedish, Norwegian, Japanese, Chinese (Simplified Chinese), Chinese (Traditional Chinese), Korean, Thai and Arabic.	English
High Altitude Mode	Use this item when using the projector at high altitudes. <ul style="list-style-type: none"> • On: Use this setting when using the projector at an altitude of 1,500 m or higher. • Off: Use this setting when using the projector at normal altitudes. 	Off
Standby Mode	Lowers the power consumption in standby mode. When set to "Low", the power consumption in standby is lowered.	Standard
Power Saving	Sets the power saving mode. When set to "On", the projector goes into power saving mode if no signal is input for 10 minutes. At that time, the ON/STANDBY indicator lights in orange, then the screen becomes dark. In power saving mode, the power saving mode is cancelled if a signal is input or any button is pressed. If you do not want to set the projector to power saving mode, select "Off".	Off
Volume	Adjusts the volume.	30
Speaker	Set to "Off" to cut the sound of the internal speakers. When set to "Off," "Speaker: Off" appears on the screen when you turn on the power.	On

Setting items	Functions	Initial setting
Input-C Signal Sel.	<p>Selects the type of signal input from the equipment connected to the INPUT C connector.</p> <p>Selects the type of signal input from the equipment by selecting “Input-C” with the INPUT key.</p> <ul style="list-style-type: none"> • Auto: Selects the input signal type automatically. • Computer: Inputs the signal from a computer. • Video GBR: Inputs the signal from a TV game or HDTV broadcast. • Component: Inputs the component signal from a DVD player/recorder, Blu-ray Disc player, digital tuner, etc. 	Auto
Color System	<p>Selects the color system of the input signal.</p> <ul style="list-style-type: none"> • Auto: Selects the color system of the input signal automatically from among NTSC_{3.58}, PAL, SECAM, NTSC_{4.43}, PAL-M, PAL-N, or PAL60. • “NTSC_{3.58}”–“PAL-N”: Allows you to set the color system to the selected system manually. 	Auto
Lamp Timer Reset	When replacing the lamps, reset the lamp timer.	–

Notes

- If you turn on “High Altitude Mode” to “On” at an altitude less than 1,500 m (4,921 feet), the projector may reduce the reliability of the lamp.
- When “High Altitude Mode” is set to “On”, the number of turns of the fan increases, and the fan noise becomes slightly louder.
- When “Standby Mode” is set to “Low,” the network presentation function and network control function cannot be operated while it is in standby mode.
- When the input signal is not displayed correctly even if “Input-C Signal Sel.” set to “Auto,” select the item according to the input signal.
- Normally, set “Color System” to “Auto.” If the picture is distorted or colorless, select the color system appropriate for the input signal.

The Function Menu

The Function menu is used for changing the settings of the various functions of the projector.

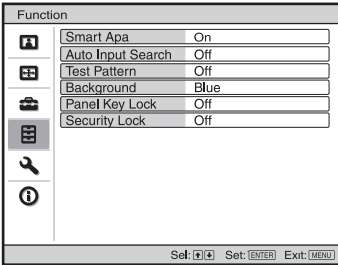

Setting items	Functions	Initial setting
Smart APA	<p>The APA (Auto Pixel Alignment) automatically adjusts “Phase,” “Pitch” and “Shift” in the Screen menu for the input signal from a computer.</p> <ul style="list-style-type: none"> • On: When a signal is input from a computer, the APA functions automatically so that the picture can be seen clearly. You can adjust the picture by pressing the APA key on the Remote Commander even if “Smart APA” set to “On.” • Off: The APA functions when you press the APA key on the Remote Commander. 	On
Auto Input Search	<p>Detects the input signal and displays the detected input signal automatically when the INPUT key is pressed. When set to “On”, the projector detects whether a Input-A, Input-B, Input-C, Input-D, Input-E, Video or S Video signal is input when the input connector with effective signals is automatically selected by pressing INPUT key. “Input-E” is displayed always. Set this to “Off” when you want to select an input selector with no input signal, or you want to switch the setting manually.</p>	Off
Test Pattern	<p>Displays the test pattern.</p> <p>When set to “On,” a test pattern appears on the screen to be used when adjusting the lens with “Focus,” “Zoom,” and “Shift,” or correcting the screen proportions with “V Keystone.” A test pattern does not appear when this item is set to “Off.”</p>	Off
Background	<p>Selects the background color of the screen when no signal is input.</p> <p>You can select “Black” or “Blue”.</p>	Blue

Setting items	Functions	Initial setting
Panel Key Lock	Locks all the control panel keys on the side panel of the projector so that the projector can be operated only with the Remote Commander. To lock the control panel keys, set to “On.” When it is set to “On,” keeping the I/⏻ key on the control panel pressed for 10 seconds turns the projector on when it is in standby mode, and turns the projector to standby mode when the power is on. If you press and hold the MENU key for about 10 seconds when the power is on, the lock will be released and “Panel Key Lock” is automatically set to “Off.”	Off
Security Lock	Turns on the projector’s security lock function. When set to “On,” turns on the security lock function, which locks the projector once a password has been set. <i>For details, see “Security Lock” on page 24.</i>	Off

Notes

- Press the APA key when the full image is displayed on the screen. If the projected image includes a black portion around it, the APA function will not work properly and some parts of the image may not be displayed on the screen.
- You can cancel the adjustment by pressing the APA key again while “Adjusting” appears on the screen.
- The picture may not be adjusted properly depending on the type of input signal.
- Adjust the “Phase,” “Pitch,” and “Shift” items in the Screen menu when you adjust the picture manually.

The Installation Menu

The Installation menu is used for changing the settings of the projector.

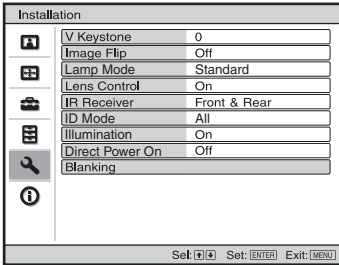

Setting items	Functions	Initial setting
V Keystone	<p>Corrects the vertical trapezoidal distortion of the picture. When the bottom of the trapezoid is longer than the top (▽): Sets a lower value (– direction). When the top of the trapezoid is longer than the bottom (△): Sets a higher value (+ direction).</p>	0
Image Flip	<p>Flips the picture on the screen horizontally and/or vertically. Use this item for installation for the backside projection or ceiling installation.</p> <ul style="list-style-type: none"> • HV: Flips the picture horizontally and vertically. • H: Flips the picture horizontally. • V: Flips the picture vertically. • Off: The picture does not flip. 	Off
Lamp Mode	<p>Sets the lamp brightness used during the projection.</p> <ul style="list-style-type: none"> • High: Illuminates the projected image brightly. • Standard: Reduces fan noise and power consumption. The brightness of the projected image will be lower compared with the “High” setting. 	Standard
Lens Control	<p>Avoids any operation of the lens such as “Focus,” “Zoom,” and “Shift,” by mistake. When set to “On,” you can adjust the projection lens using “Focus,” “Zoom,” and “Shift.” After you make this adjustment, it is recommended that you set this item to “Off” to avoid any operation of the lens. When set to “Off,” the FOCUS, ZOOM and SHIFT keys do not work.</p>	On
IR Receiver	<p>Selects the remote control detectors (IR Receiver) on the front and rear of the projector.</p> <ul style="list-style-type: none"> • Front & Rear: Activates both the front and rear detectors. • Front: Activates the front detector only. • Rear: Activates the rear detector only. 	Front & Rear

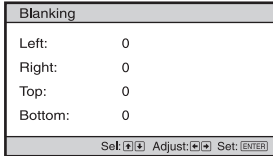
Setting items	Functions	Initial setting
ID Mode	Assigns an ID number (1 to 3) to the projector when you want control two or more projectors individually with the supplied Remote Commander. When this item is set to "1," you can control the projector with the Remote Commander with the ID MODE key set to "1." When it is set to "All," you can control all the projectors with the Remote Commander independently of the ID MODE keys of the Remote Commander.	All
Illumination	Selects whether the SONY logo on the top panel of the projector lights when the projector is on.	On
Direct Power On	Set to "On" if you are using a circuit breaker to turn the power on/off the entire system. You can turn the power on/off without pressing the power key on the projector.	Off
Blanking	Adjust the displayable area within the four directions of the screen. Select each screen edge "left / right / up / bottom" on the Blanking adjustment screen with \uparrow / \downarrow key. Adjust the desired Blanking value with \leftarrow / \rightarrow key. 	0

Notes

- Since the V keystone function is an electronic correction, sometimes the image will be deteriorated.
- Depending on the picture position adjusted with the lens shift feature, the aspect ratio of the picture may change from the original or picture distortion may occur with V Keystone adjustment.
- When both Blanking and V Keystone are adjusted at the same time, Blanking may not function properly. When you use Blanking, set the V Keystone to "0."
- Since the displayable area becomes narrower when Blanking value is adjusted, information necessary on Input-E may not be displayed.

The Information Menu

The Information menu displays the model name, serial number, the horizontal and vertical frequencies of the input signal and the cumulated hours of usage of the lamp.

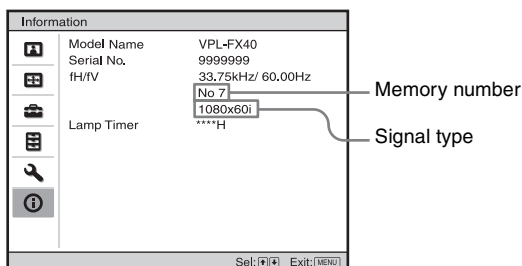

Setting items	Functions
Model Name	Displays the model name.
Serial No.	Displays the serial number.
fH (horizontal frequency)	Displays the horizontal frequency of the input signal.
fV (vertical frequency)	Displays the vertical frequency of the input signal.
Memory number	Displays the preset memory number of the input signal.
Signal Type	Displays the type of the input signal.
Lamp Timer	Indicates how long the lamp has been turned on (total usage).

Notes

- fH (horizontal frequency) and fV (vertical frequency) may not be displayed depending on the input signal used on the projector.
- You cannot change the displays listed above.

Input signals and adjustable/setting items

Some of the items in the menus cannot be adjusted depending on the input signal as indicated in the following tables. The items that cannot be adjusted are not displayed in the menu.

Picture menu

Item	Input signal				
	Video/S-Video (Y/C)	Component	Video GBR	Computer	Network
Picture Mode	●	●	●	●	●
Contrast	●	●	●	●	●
Brightness	●	●	●	●	●
Color	●*1	●	●	–	–
Hue	●*2	●	●	–	–
Color Temperature	●	●	●	●	●

Item	Input signal				
	Video/S-Video (Y/C)	Component	Video GBR	Computer	Network
Sharpness	●	●	●	—	—
DDE	●	● ^{*4}	● ^{*4}	—	—
Black Level Adj.	●	●	●	—	—
Gamma Mode	—	—	● ^{*3}	●	●

● : Adjustable/can be set

— : Not adjustable/cannot be set

*1: Except B & W

*2: NTSC_{3.58} and NTSC_{4.43} only, except B & W

*3: Preset memory No. 3, 4 only.

*4: Preset memory No. 1 - 4, 7, 8 only

Screen menu

Item	Input signal				
	Video/S-Video (Y/C)	Component	Video GBR	Computer	Network
Aspect	●	●	●	● ^{*5}	—
Over Scan	—	●	●	—	—
Adjust Signal					
APA	—	—	—	● ^{*6}	—
Phase	—	—	—	● ^{*6}	—
Pitch	—	—	—	● ^{*6}	—
Shift	—	●	●	●	—

● : Adjustable/can be set

— : Not adjustable/cannot be set

*5: VPL-FE40: Can be set except preset memory numbers 50 and 51.

VPL-FX40/FX41: Can be set except preset memory numbers 37, 38, 39, 40, 45, 46, 50 and 51.

*6: Except HDMI input.

Replacing the Lamp

The lamp used as a light source is a consumable product. Thus replace this lamp with a new one in the following cases.

- When the lamp has burnt out or dims
- “Please replace the Lamp and clean the Filter.” appears on the screen.
- The LAMP/COVER indicator flashes in red. (Repetition rate of 3 flashes)

The lamp life varies depending on conditions of use.

Use an LMP-F270 Projector Lamp as the replacement lamp.

Use of any other lamps than the LMP-F270 may cause damage to the projector.

Caution

The lamp remains hot after the projector is turned off with the I/⏻ key. **If you touch the lamp, you may burn your finger. When you replace the lamp, wait for at least an hour for the lamp to cool.**

Notes

- If the lamp breaks, consult with qualified for personal.
- Pull out the lamp by holding the knob. If you touch the lamp, you may be burned or injured.
- When removing the lamp, make sure it remains horizontal, then pull straight out. Do not tilt the lamp. If you pull out the lamp while it is tilted and if the lamp breaks, the pieces may scatter, causing injury.

- 1 Turn off the projector, and disconnect the AC power cord from the AC outlet.

Note

When replacing the lamp after using the projector, wait for at least an hour for the lamp to cool.

- 2 Open the lamp cover by loosening the three screws with a Phillips screwdriver.

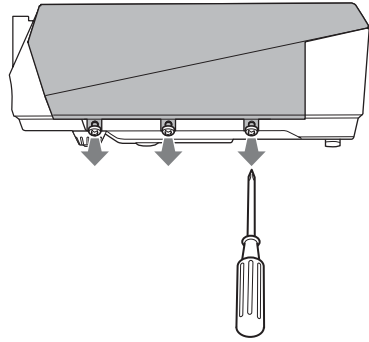

- 3 Remove the lamp cover by lifting it forward with the fingers placed on the slit of the projector.

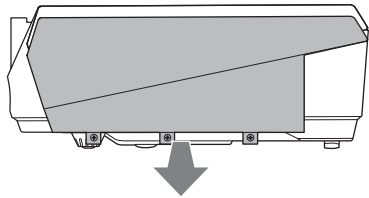

- 4 Loosen the two screws on the lamp unit with the Phillips screwdriver (1), hold the knob (2), then pull out the lamp unit.

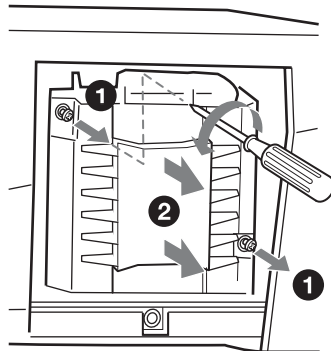

- 5 Insert the new lamp all the way in until it is securely in place (1). Tighten the two screws (2).

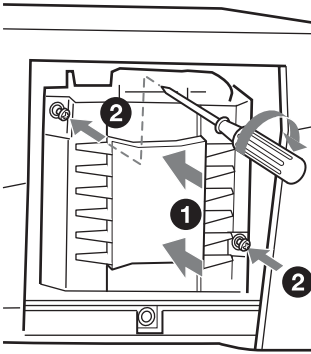

Notes

- Be careful not to touch the glass surface of the lamp.
- The power will not turn on if the lamp is not secured properly.

6 Restore the lamp cover to the original position and tighten the three screws with the phillips screwdriver.

Note

Be sure to attach the lamp cover securely as it was. If not, the projector cannot be turned on.

7 Connect the power cord.
The ON/STANDBY indicator lights in red.

8 Press the I/⏻ key to turn the projector on.

9 Press the MENU key, and then select the Setup menu.

10Select “Lamp Timer Reset”, and then press the ENTER key.
A message is displayed.

11Select “Yes”, and then press the ENTER key.
The Lamp Timer is initialized to 0, and “Lamp Timer Reset Complete!” is displayed in the menu screen.

12Select “OK.”

Caution

Do not put your hands into the lamp replacement slot, and do not allow any liquid or other objects into the slot **to avoid electrical shock or fire.**

Note

To erase a message, press any key on the control panel of the projector or on the Remote Commander.

Disposal of the used lamp

For the customers in the USA

Lamp in this product contains mercury. Disposal of these materials may be regulated due to environmental considerations. For disposal or recycling information, please contact your local authorities or the Electronic Industries Alliance (www.eiae.org).

Cleaning the Air Filter

The air filter should be cleaned whenever you replace the lamp. Remove the air filter, and then remove the dust with a vacuum cleaner. The time needed to clean the air filter will vary depending on the environment or how the projector is used.

- 1 Turn the power off and unplug the power cord.
- 2 Remove the air filter covers. The air filter of the VPL-FX41 is on one side **a** only.

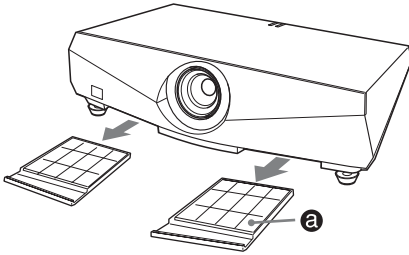

- 3 Remove the air filter from the each claws (6 positions) on the air filter cover.

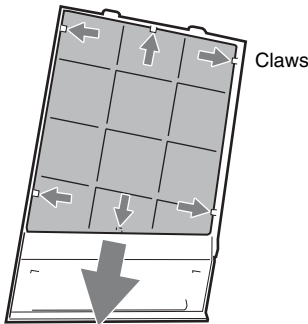

- 4 Clean the air filter with a vacuum cleaner.

- 5 Attach the air filter so that it fits into the each claws (6 positions) on the air filter covers and replace the cover.

Caution

If you neglect to clean the air filter, dust may accumulate, clogging it. As a result, the temperature may rise inside the unit, leading to a possible malfunction or fire.

Notes

- If the dust cannot be removed from the air filter, replace the air filter with a new one. For details on new air filter, consult with qualified Sony personnel.
- Be sure to attach the air filter cover firmly; the power can not be turned on if it is not closed securely.
- The air filter has face and reverse sides. Attach the air filter so that the frames on the air filter are visible.
- To erase a message, press any key on the control panel of the projector or on the remote commander.

Troubleshooting

If the projector appears to be operating erratically, try to diagnose and correct the problem using the following instructions. If the problem persists, consult with qualified Sony personnel.

Power

Symptom	Cause and Remedy
The power is not turned on.	<ul style="list-style-type: none"> • The power has been turned off and on with the I/⏻ key at a short interval. → Wait for about 60 seconds before turning on the power (see page 22). • The lamp cover is not secured. → Close the lamp cover securely (see page 42). • The air filter cover is detached. → Attach the air filter cover securely (see page 43).

Picture

Symptom	Cause and Remedy
No picture.	<ul style="list-style-type: none"> • A cable is disconnected or the connections are wrong. → Check that the proper connections have been made (see page 17). • The connections are wrong. → This projector is compatible with DDC2B (Digital Data Channel 2B). If your computer is compatible with DDC, turn the projector on according to the following procedures. <ol style="list-style-type: none"> 1 Connect the projector to the computer. 2 Turn the projector on. 3 Start the computer. • Input selection is incorrect. → Select the input source correctly using the INPUT key (see page 20). • The picture is muted. → Press the PIC MUTING key to release the picture muting (see page 15). • The computer signal is not set to output to an external monitor or set to output both to an external monitor and a LCD monitor of a computer. → Set the computer signal to output only to an external monitor (see page 17).
The picture is noisy.	<ul style="list-style-type: none"> • Noise may appear on the background depending on the combination of the number of dots input from the computer and the numbers of pixels on the LCD panel. → Change the desktop pattern on the connected computer. • Input a video signal with the jitter. → Use a TBC (Time Base Corrector) to try to reduce video jitter.
The picture from the INPUT C connector is colored strangely.	<p>The setting of “Input-C Signal Sel.” in the Setup menu is incorrect.</p> <p>→ Select “Computer,” “Video GBR” or “Component” correctly according to the input signal (see page 34).</p>

Symptom	Cause and Remedy
“Please check Input-C Signal Sel.” appears in spite of inputting the correct signal from INPUT C.	The setting of “Input-C Signal Sel.” in the Setup menu is incorrect. → Select “Computer,” “Video GBR” or “Component” correctly according to the input signal (see page 34).
On-screen display does not appear.	“Status” in the Setup menu has been set to “Off.” → Set “Status” in the Setup menu to “On” (see page 33).
Color balance is incorrect.	<ul style="list-style-type: none"> • The picture has not been adjusted properly. → Adjust the picture (see page 29). • The projector is set to the wrong color system. → Set “Color System” in the Setup menu to match the color system being input (see page 34).
The picture is too dark.	<ul style="list-style-type: none"> • Contrast or brightness has not been adjusted properly. → Adjust the contrast or brightness in the Picture menu properly (see page 29). • The lamp has burnt out or is dim. → Replace the lamp with a new one (see page 41).
The picture is not clear.	<ul style="list-style-type: none"> • The picture is out of focus. → Adjust the focus (see page 21). • Condensation has accumulated on the lens. → Leave the projector for about two hours with the power on.
The image extends beyond the screen.	The APA key has been pressed even though there are black edges around the image. → Display the full image on the screen and press the APA key. → Adjust “Shift” in the Screen menu properly (see page 32).
The picture flickers.	“Phase” in the Screen menu has not been adjusted properly. → Adjust “Phase” in the Screen menu properly (see page 32).

Sound

Symptom	Cause and Remedy
No sound.	<ul style="list-style-type: none"> • A cable is disconnected or the connections are wrong. → Check that the proper connections have been made (see page 17). • The audio connecting cable used is incorrect. → Use a no-resistance stereo audio cable (see page 17). • The sound is muted. → Press the AUDIO MUTING key to release audio muting (see page 15). • The sound is not adjusted properly. → Adjust the sound with the VOLUME +/- key on the Remote Commander or adjust “Volume” in the Setup menu (see page 33). • “Speaker” is set to “Off.” → Set “Speaker” in the Setup menu to “On” (see page 33).

Remote Commander

Symptom	Cause and Remedy
The Remote Commander does not work.	<ul style="list-style-type: none"> • The Remote Commander batteries are dead. <ul style="list-style-type: none"> → Replace them with new batteries (see page 15). • The COMMAND ON/OFF switch is set to OFF. <ul style="list-style-type: none"> → Set it to ON. • The ID number of the projector assigned in “ID Mode” in the Installation menu does not match the ID number of the ID MODE keys on the Remote Commander. <ul style="list-style-type: none"> → Assigns the same ID number to the projector and the Remote Commander, or set “ID Mode” in the Installation menu to “All.”

Others

Symptom	Cause and Remedy
The control panel keys do not function.	The control panel keys are locked. → Unlock the control panel keys (see page 36).
The fan is noisy.	<ul style="list-style-type: none"> → Check the setting of “High Altitude Mode” in the Setup menu (see page 33). → Check the ventilation holes are not blocked. → Make sure the room temperature is not too high. To maintain the product reliability of the projector’s components, the rotation speed of the fan increases and the fan becomes slightly noisier, when the room temperature exceeds normal. The approximate normal temperature is 25°C.
An afterimage appears.	→ If a still image with strong contrast is displayed in the same location on the screen continuously, an afterimage may appear temporarily. It will disappear shortly after the display changes.

Indicators

Symptom	Cause and Remedy
The LAMP/COVER indicator flashes in orange. (Repetition rate of 2 flashes)	<ul style="list-style-type: none"> • The lamp cover or the air filter cover is detached. <ul style="list-style-type: none"> → Attach the cover securely (see pages 42 and 43).
The LAMP/COVER indicator flashes in orange. (Repetition rate of 3 flashes)	<ul style="list-style-type: none"> • The lamp has reached the end of its life. <ul style="list-style-type: none"> → Replace the lamp (see page 41). • The lamp has reached a high temperature. <ul style="list-style-type: none"> → Wait for 60 seconds to cool the lamp and then turn on the power again.
ON/STANDBY flashes in red. (Repetition rate of 2 flashes)	<ul style="list-style-type: none"> • The internal temperature is unusually high. <ul style="list-style-type: none"> → Check to see that nothing is blocking the ventilation holes. • The projector is being used at a high altitude. <ul style="list-style-type: none"> → Ensure that “High Altitude Mode” in the Setup menu is set to “On.”
ON/STANDBY flashes in red. (Repetition rate of 4 flashes)	The fan is broken. → Consult with qualified Sony personnel.
ON/STANDBY flashes in red. (Repetition rate of 6 flashes)	Unplug the AC power cord from the wall outlet after the ON/STANDBY indicator goes out, plug the power cord to the wall outlet, and then turn the projector on again. If the ON/STANDBY flashes in red and the problem persists, the electrical system has failed. → Consult with qualified Sony personnel.

Messages List

Warning Messages

Use the list below to check the meaning of the messages displayed on the screen.

Message	Meaning and Remedy
High temp.! Lamp off in 1 min.	The internal temperature is too high. → Turn off the power. → Check to see that nothing is blocking the ventilation holes.
Frequency is out of range!	<ul style="list-style-type: none"> • This input signal cannot be projected as the frequency is out of the acceptable range of the projector. • The resolution setting of the output signal of the computer is too high. → Input a signal that is within the range of the frequency.
Please check Input-C Signal Sel.	You have input an RGB signal from the computer when “Input-C Signal Sel.” in the Setup menu is set to “Component.” → Set “Input-C Signal Sel.” correctly (see page 34).
Please replace the Lamp and clean the Filter.	<ul style="list-style-type: none"> • It is time to replace the lamp and clean the air filter. → Replace the lamp (see page 41) and clean the filter (see page 43). • If this message appears again after you replace the lamp, the lamp replacement process is not complete. → Perform the operations in step 8 to 11 on page 42. <p>Note</p> To erase a message, press any key on the control panel of the projector or on the remote commander.
The projector temperature is high. “High Altitude Mode” should be “On” if the projector is being used at high altitude.	→ Check to ensure that the ventilation holes on the projector are not covered (see page 11). → When using the projector at high altitude, set the “High Altitude Mode” to “On”. <p>Note</p> If the temperature inside the projector remains high, the “High Altitude Mode” is switched to “On” in one minute, then the fan speed increases.

Caution Messages

Use the list below to check the meaning of the messages displayed on the screen.

Message	Meaning and Remedy
Not applicable!	You have pressed the wrong key. → Press the appropriate key.
The panel keys are locked!	“Panel Key Lock” in the Function menu is set to “On.” → All the keys on the control panel of the projector are locked. Operate the projector with the keys on the Remote Commander (see page 36).

Specifications

Optical characteristics

Projection system	3 LCD panels, 1 lens, 3 primary color shutter system
LCD panel	VPL-FE40: 0.79-inch SXGA+ panel, 4,410,000 pixels (1400 × 1050 × 3) VPL-FX40/FX41: 0.79-inch XGA panel, 2,359,296 pixels (1024 × 768 × 3)
Lens	1.3 times zoom lens (powered) f 30.6 to 39.7 mm/F1.66 to 2.18 * The lens is not supplied with the VPL-FE40L/FX40L/FX41L.
Lamp	275 W Ultra high pressure lamp
Projected picture size	40 to 600-inches (measured diagonally) (When the VPLL-1008 is used: 60 to 300-inch)
Light output	VPL-FE40/FX40: 4000 ANSI lumen VPL-FX41: 5200 ANSI lumen (When the Lamp Mode is set to "High.")
Throwing distance (When placed on the floor.)	When an SXGA+ (VPL-FE40)/XGA (VPL-FX40/FX41) signal is input 40-inch: 1.5 to 1.9 m (4.9 to 6.2 feet) 60-inch: 2.3 to 2.9 m (7.4 to 9.5 feet) 80-inch: 3.0 to 3.9 m (9.9 to 12.7 feet) 100-inch: 3.8 to 4.8 m (12.5 to 15.9 feet) 120-inch: 4.6 to 5.8 m (15.0 to 19.1 feet) 150-inch: 5.7 to 7.3 m (18.8 to 23.9 feet) 200-inch: 7.7 to 9.7 m (25.2 to 32.0 feet) 300-inch: 11.6 to 14.6 m (37.9 to 48.0 feet) 400-inch: 15.4 to 19.5 m (50.6 to 64.1 feet) 500-inch: 19.3 to 24.4 m (63.3 to 80.2 feet) 600-inch: 23.2 to 29.4 m (76.0 to 96.3 feet)

There may be a slight difference between the actual value and the design value shown above.

Electrical characteristics

Color system	NTSC3.58/PAL/SECAM/ NTSC4.43/PAL-M/PAL-N/ PAL60 system, switched automatically/manually (NTSC4.43 is the color system used when playing back a video recorded in NTSC on a NTSC4.43 system VCR.)
Resolution	VPL-FE40: 750 horizontal TV lines (Video input) 1,400 × 1,050 dots (RGB input) VPL-FX40/FX41: 750 horizontal TV lines (Video input) 1,024 × 768 dots (RGB input)
Acceptable computer signals ¹⁾	fH: 19 to 92 kHz fV: 48 to 92 Hz (Maximum input signal resolution: UXGA 1600 × 1200 fV: 60 Hz)

¹⁾ Set the resolution and the frequency of the signal of the connected computer within the range of acceptable preset signals of the projector.

Applicable video signals

15 k RGB 50/60 Hz, Progressive component 50/60 Hz, DTV (480/60i, 575/50i, 480/60p, 575/50p, 720/60p, 720/50p, 1080/60i, 1080/50i, 1080/60p, 1080/50p), Composite video, Y/C video

Speaker Stereo speaker system, 40 × 70 mm (1 ⁵/₈ × 2 ⁷/₈ inches)

Speaker output 1.8 W × 2

Input/Output

VIDEO IN	VIDEO: phono type Composite video: 1 Vp-p ±2 dB sync negative (75 ohms terminated) S VIDEO: Y/C mini DIN 4-pin type Y (luminance): 1 Vp-p ±2 dB sync negative (75 ohms terminated) C (chrominance): burst 0.286 Vp-p ±2 dB (NTSC) (75 ohms terminated), burst 0.3 Vp-p ±2 dB (PAL) (75 ohms terminated) AUDIO: phono type × 2 rated input 500 mVrms, input
----------	---

impedance more than 47 kilohms

INPUT A/B Analog RGB: HD D-sub 15-pin (female)
 R: 0.7 V_{p-p} ±2 dB (75 ohms terminated)
 G: 0.7 V_{p-p} ±2 dB (75 ohms terminated)
 B: 0.7 V_{p-p} ±2 dB (75 ohms terminated)
 HD: Horizontal sync input: TTL level, high impedance, positive/negative
 VD: Vertical sync input: TTL level, high impedance, positive/negative

INPUT C Analog RGB/component: 5BNC (female)
 R/R-Y: 0.7 V_{p-p} ±2 dB (75 ohms terminated)
 G: 0.7 V_{p-p} ±2 dB (75 ohms terminated)
 G with sync/Y: 1 V_{p-p} ±2 dB sync negative (75 ohms terminated)
 (Except computer signals)
 B/B-Y: 0.7 V_{p-p} ±2 dB (75 ohms terminated)
 HD:
 Horizontal sync input: TTL level, high impedance, positive/negative
 VD:
 Vertical sync input: TTL level, high impedance, positive/negative

AUDIO: Stereo minijack rated input 500 mVrms, input impedance more than 47 kilohms

INPUT D Digital RGB/Y CB (Pb) CR (Pr): HDMI

INPUT E NETWORK
 RJ-45: 10BASE-T/100BASE-TX

OUTPUT MONITOR OUT: HD D-sub 15-pin (female)
 R, G, B: Gain Unity: 75 ohms
 HD, VD: 4 V_{p-p} (open), 1 V_{p-p} (75 ohms)
 AUDIO OUT (variable out): Stereo minijack
 1 Vrms (When the volume is maximum and an input signal is

500 mVrms), output impedance 5 kilohms

REMOTE CONTROL S RS-232C: D-sub 9 pin
 IN/PLUG IN POWER Stereo minijack

General

Dimensions 532 × 145 × 352 mm (21 × 5³/₈ × 13⁷/₈ inches) (w/h/d) (without the projection parts)

Mass Approx. 9.8 kg (21 lb 10 oz) (VPL-FE40/FX40/FX41)
 Approx. 9.0 kg (19 lb 13 oz) (VPL-FE40L/FX40L/FX41L)

Power requirements AC 100 to 240 V, 4.1 - 1.7 A, 50/60 Hz

Power consumption Max. 400 W
 (in standby (standard): 15 W in standby (low): 0.5 W)

Heat dissipation 1365 BTU

Operating temperature 0°C to 35°C (32°F to 95°F)

Operating humidity 35% to 85% (no condensation)

Storage temperature -20°C to +60°C (-4°F to +140°F)

Storage humidity 10% to 90%

Supplied accessories
 Remote Commander (1)
 Size AA (R6) batteries (2)
 Lens cap (1) (VPL-FE40/FX40/FX41)
 Lens hole cover (1) (VPL-FE40L/FX40L/FX41L)
 AC power cord (1)
 CD-ROM (Operating Instructions, Application Software) (1)
 Quick Reference Manual (1)
 Safety Regulations (1)
 Security Label (1)

Design and specifications are subject to change without notice.

Note

Always verify that the unit is operating properly before use. SONY WILL NOT BE LIABLE FOR DAMAGES OF ANY KIND INCLUDING, BUT NOT LIMITED TO, COMPENSATION OR REIMBURSEMENT ON ACCOUNT OF THE LOSS OF PRESENT OR PROSPECTIVE PROFITS DUE TO FAILURE OF THIS UNIT, EITHER DURING THE WARRANTY PERIOD OR

AFTER EXPIRATION OF THE WARRANTY, OR FOR ANY OTHER REASON WHATSOEVER.

Optional accessories

- Projector Lamp
 - LMP-F270 (for replacement)
- Projector Suspension Support
 - PSS-610
- Presentation Tool
 - RM-PJPK1
- Projection Lense
 - Fixed short focus lens VPLL-1008
 - (for rear projection (Optical Axis Angle: 0 degree))
 - F = 2.0
 - f = 13.1 mm
 - Manual focus
 - Projection screen size
 - 60 to 300-inches
 - Projection distance
 - 100 inches: 1590 mm
 - 200 inches: 3250 mm
 - 300 inches: 4910 mm
 - Maximum external dimensions
 - 130 × 130 × 242 mm (W × H × D)
 - Weight
 - 1500 g
 - Short focus zoom lens VPLL-Z1014
 - F = 2.0 - 2.8
 - f = 22.8 to 31.4 mm
 - Powered focus/zoom
 - Projection screen size
 - 40 to 600-inches
 - Projection distance
 - 100 inches: 2850 to 3830 mm
 - 200 inches: 5760 to 7710 mm
 - 300 inches: 8670 to 11600 mm
 - Maximum external dimensions
 - 102 × 102 × 192 mm (W × H × D)
 - Weight
 - 1330 g
 - Middle focus zoom lens VPLL-Z1024
 - F = 2.0 - 2.3
 - f = 37.8 to 54.3 mm
 - Powered focus/zoom
 - Projection screen size
 - 40 to 600-inches
 - Projection distance
 - 100 inches: 4840 to 6630 mm
 - 200 inches: 9770 to 13350 mm
 - 300 inches: 14700 to 20060 mm
 - Maximum external dimensions
 - 97 × 87 × 180 mm (W × H × D)
 - Weight
 - 1140 g

- Long focus zoom lens VPLL-Z1032
 - F = 2.0 to 2.4
 - f = 52.6 to 84.3 mm
 - Powered focus/zoom
 - Projection screen size
 - 40 to 600-inches
 - Projection distance
 - 100 inches: 6580 to 10060 mm
 - 200 inches: 13310 to 20240 mm
 - 300 inches: 20040 to 30430 mm
 - Maximum external dimensions
 - 97 × 87 × 177 mm (W × H × D)
 - Weight
 - 1140 g

Some of the items may not be available in some areas. For details, please consult your nearest Sony dealer.

Pin assignment

INPUT A/B

RGB connector (HD D-sub 15-pin, female)

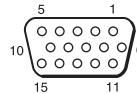

1	R	9	Power supply input for DDC
2	G	10	GND
3	B	11	GND
4	GND	12	DDC/SDA
5	GND	13	HD
6	GND (R)	14	VD
7	GND (G)	15	DDC/SCL
8	GND (B)		

REMOTE

RS-232C connector (D-sub 9 pin, female)

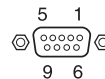

1	NC	6	NC
2	RXDA	7	RTS
3	TXDA	8	CTS
4	DTR	9	NC
5	GND		

Preset signals

Memory No.	Preset signal		fH (kHz)	fV (Hz)	Sync	Analog signals	Digital signals
1	Video 60 Hz	Video 60 Hz	15.734	59.940	–	●	
2	Video 50 Hz	Video 50 Hz	15.625	50.000	–	●	
3	480/60i	DTV 480/60i	15.734	59.940	S on G/Y	●	●
4	575/50i	DTV 575/50i	15.625	50.000	S on G/Y	●	●
5	480/60p	480/60p (NTSC Progressive component)	31.470	60.000	S on G/Y	●	●
6	575/50p	575/50p (PAL Progressive component)	31.250	50.000	S on G/Y	●	●
7	1080/60i	1035/60i, 1080/60i	33.750	60.000	S on G/Y	●	●
8	1080/50i	1080/50i	28.130	50.000	S on G/Y	●	●
10	720/60p	720/60p	45.000	60.000	S on G/Y	●	●
11	720/50p	720/50p	37.500	50.000	S on G/Y	●	●
12	1080/60p	1080/60p	67.500	60.000	S on G/Y		●
13	1080/50p	1080/50p	56.260	50.000	S on G/Y		●
14	1080/24p	1080/24p	26.973	23.976	S on G/Y		●
15	1080/30p	1080/30p	33.750	29.970	S on G/Y		●
21	640 × 350	VGA mode 1 (VGA 350)	31.469	70.086	H-pos, V-neg	●	
22		VESA 85 (VGA 350)	37.861	85.080	H-pos, V-neg	●	
23	640 × 400	NEC PC 98	24.823	56.416	H-neg, V-neg	●	
24		VGA mode 2 (TEXT)/VESA 70	31.469	70.086	H-neg, V-pos	●	
25		VESA 85 (VGA 400)	37.861	85.080	H-neg, V-pos	●	
26	640 × 480	VESA 60	31.469	59.940	H-neg, V-neg	●	●
27		Mac 13	35.000	66.667	H-neg, V-neg	●	
28		VESA 72	37.861	72.809	H-neg, V-neg	●	
29		VESA 75 (IBM M3)	37.500	75.000	H-neg, V-neg	●	
30		VESA 85 (IBM M4)	43.269	85.008	H-neg, V-neg	●	

Others

Memory No.	Preset signal		fH (kHz)	fV (Hz)	Sync	Analog signals	Digital signals
31	800 × 600	VESA 56	35.156	56.250	H-pos, V-pos	●	
32		VESA 60	37.879	60.317	H-pos, V-pos	●	●
33		VESA 72	48.077	72.188	H-pos, V-pos	●	
34		VESA 75 (IBM M5)	46.875	75.000	H-pos, V-pos	●	
35		VESA 85	53.674	85.061	H-pos, V-pos	●	
36	832 × 624	Mac 16	49.724	74.550	H-neg, V-neg	●	●
37	1024 × 768	VESA 60	48.363	60.004	H-neg, V-neg	●	●
38		VESA 70	56.476	70.069	H-neg, V-neg	●	
39		VESA 75	60.023	75.029	H-pos, V-pos	●	
40		VESA 85	68.677	84.997	H-pos, V-pos	●	
45	1280 × 960	VESA 60	60.000	60.000	H-pos, V-pos	●	●
46		VESA 75	75.000	75.000	H-pos, V-pos	●	
47	1280 × 1024	VESA 60	63.974	60.013	H-pos, V-pos	●	●
48		VESA 75	79.976	75.025	H-pos, V-pos	●	
49		VESA 85	91.146	85.024	H-pos, V-pos	●	
50	1400 × 1050	VESA 60	65.317	59.978	H-neg, V-pos	●	●
51	1600 × 1200	VESA 60	75.000	60.000	H-pos, V-pos	●	
55	1280 × 768	1280 × 768/60	47.776	59.870	H-neg, V-pos	●	●
56	1280 × 720	1280 × 720/60	44.772	59.855	H-neg, V-pos	●	
60	1360 × 768	1360 × 768/60	47.720	59.799	H-neg, V-pos	●	●
61	1440 × 900	1440 × 900/60	55.935	59.887	H-neg, V-pos	●	●
62	1680 × 1050	1680 × 1050/60	65.290	59.954	H-neg, V-pos	●	●

Memory No.	Preset signal		fH (kHz)	fV (Hz)	Sync	Analog signals	Digital signals
63	1280 × 800	1280 × 800/60	49.702	59.810	H-neg, V-pos	●	●

Preset memory No. at the input signal

Analog signals

Signal	Preset memory No.
Video (Video, S video connector)	1, 2
Component (Input-C connector)	3-8, 10-11
Video GBR (Input-C connector)	3-8, 10-11
Computer (Input-A, Input-B, Input-C connector)	21-40, 45-51, 55, 56, 60-63

Digital signals

Signal	Preset memory No.
Component (Input-D connector)	3-8, 10-15
Video GBR (Input-D connector)	3-8, 10-15
Computer (Input-D connector)	26, 32, 36, 37, 45, 47, 50, 55, 60-63

Notes

- When a signal other than the preset signals shown above is input, the picture may not be displayed properly.
- An input signal meant for screen resolution different from that of the panel will not be displayed in its original resolution. Text and lines may be uneven.

Dimensions

Front

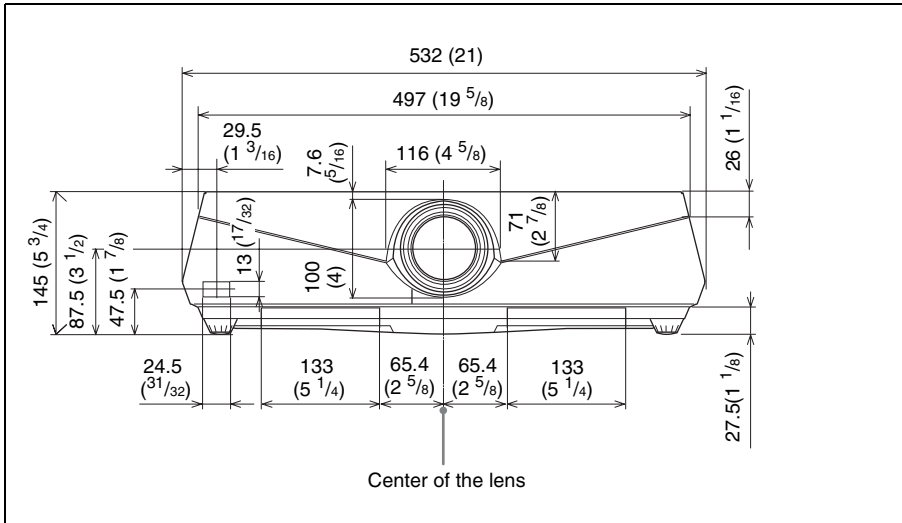

Top

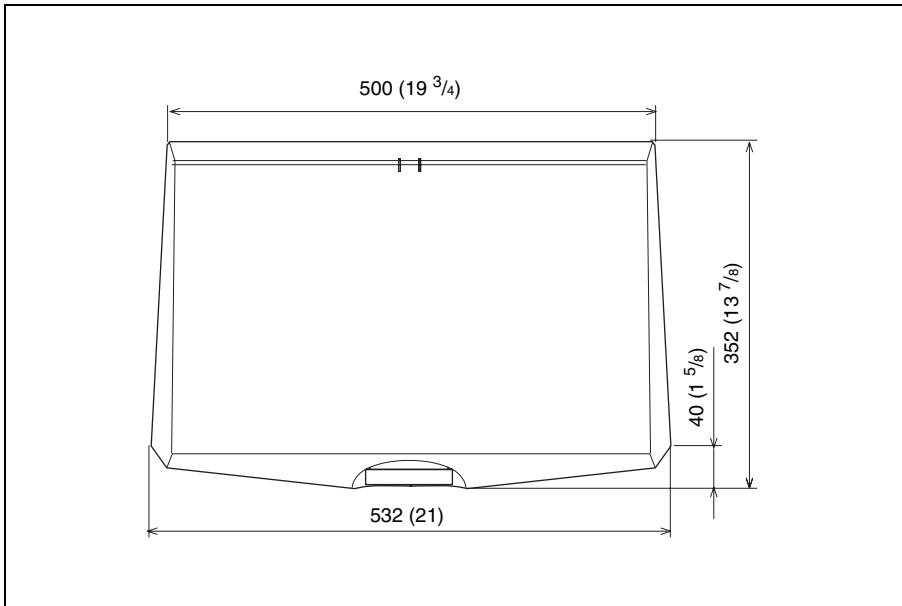

Unit: mm (inches)

Side

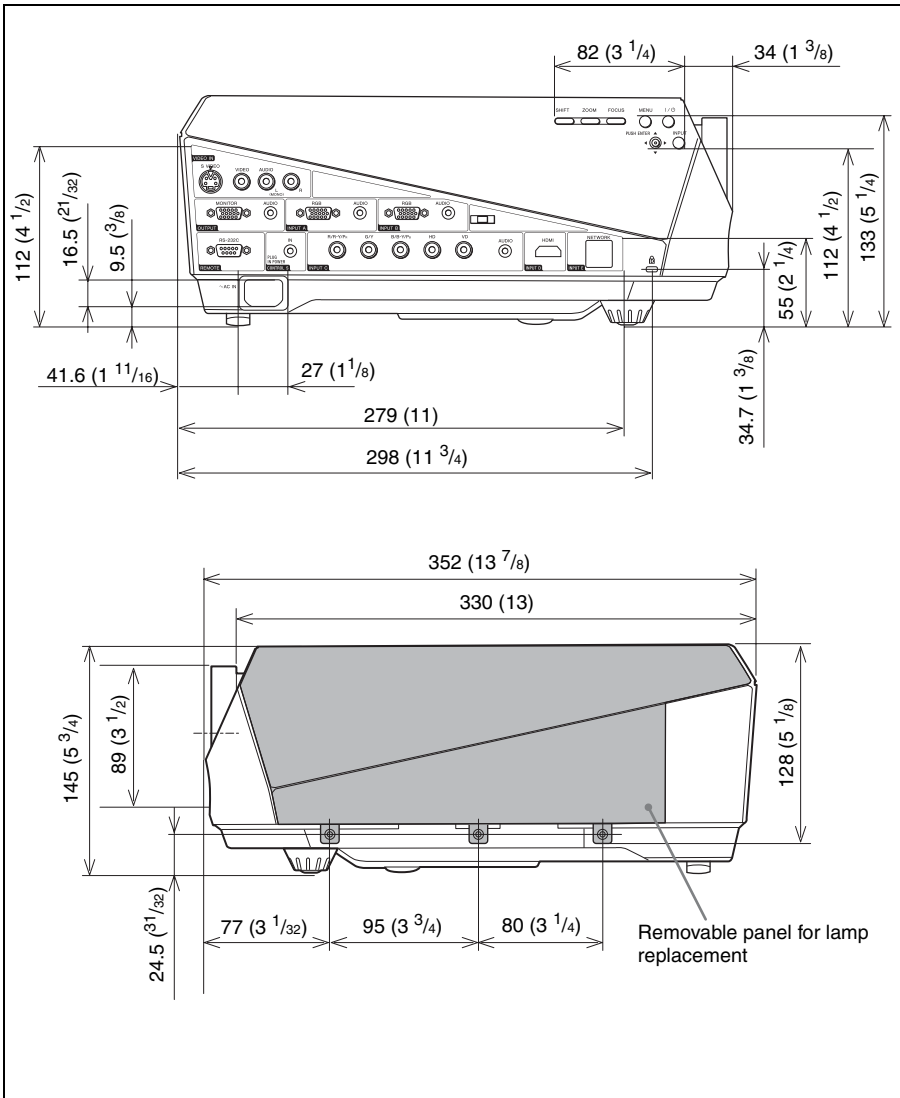

Unit: mm (inches)

Others

Rear

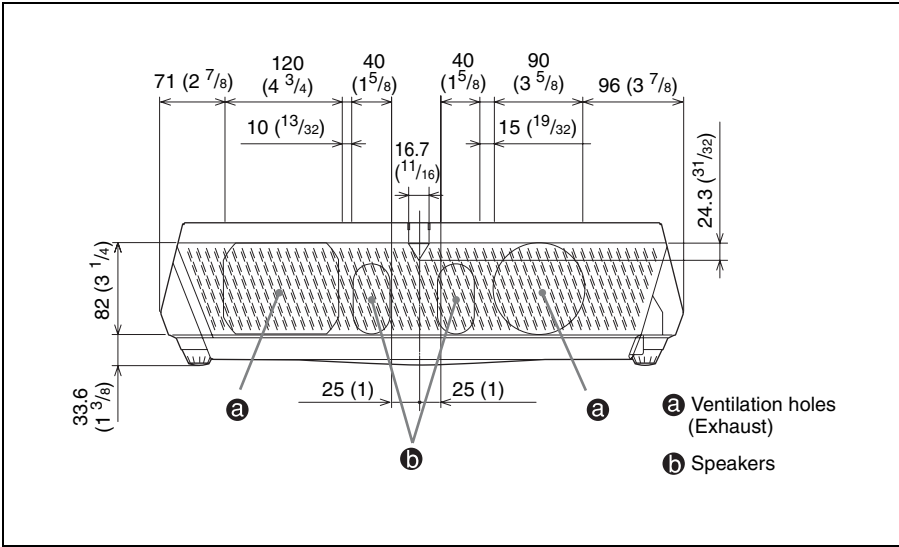

Bottom

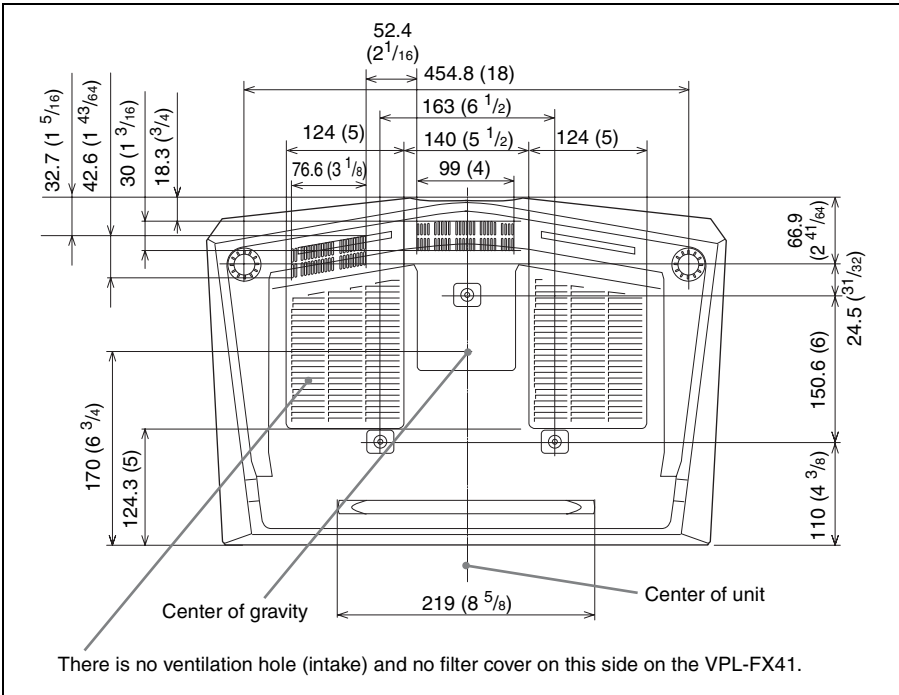

Unit: mm (inches)

Index

A

Adjust Signal	
APA	32
Phase	32
Pitch	32
Shift	32
Adjusting	
memory of the settings	28
Air filter	43
Aspect	
16:9	31
4:3	31
Full 1	31
Full 2	31
Normal	31
Zoom	31
Auto Input Search	35

B

Background	35
Batteries	15
Black Level Adj.	30
Blanking	38
Brightness	29

C

Color	29
Color System	34
Color Temp.	29
Connecting a computer	17
Connecting a VCR	19
Contrast	29

D

DDE	30
Direct Power On	38

F

fH	39
fV	39

G

Gamma Mode	30
------------------	----

H

High Altitude Mode	33
--------------------------	----

Hue	29
-----------	----

I

Illumination	38
Image Flip	37
Input-C Signal Sel.	34
Installation	16
Installation examples	
unsuitable conditions	7
unsuitable installation	6

L

Lamp Mode	37
Lamp replacement	41
Lamp Timer	39
Language	33
selecting the menu language	23
Lens	10
Location and function of controls	
connector panel	12
control panel	11
rear/side/bottom	10
Remote Commander	14
top/front/side	10

M

Menu	
clearing the menu display	28
Function menu	35
Information menu	39
Installation menu	37
Picture menu	29
Screen menu	31
Setup menu	33
using the menu	27
Message List	
caution	47
warning	47

O

Off & Go function	26
Optional accessories	50
Over Scan	31

P

Panel Key Lock	36
Picture Mode	29
Pin assignment	50
Power	
turn off	22

Precautions 5
Projecting 20

R

Remote Commander 14
 front remote control detector 10
 location and function of controls 14
 rear remote control detector 11
Reset 29
 resetting an item 28

S

Screen size 16, 48
Security Lock 36
Sharpness 29
Smart APA 35
Specifications 48
Standby Mode 33
Status 33
Supplied accessories 49

T

Troubleshooting 44

V

V Keystone 37

